

Яндекс



Эффективная маршрутизация в вычислительном облаке (PG-13)

Рим Зайдуллин
Code Wizard



Настало время офигительных историй



ROUTE TO THE CLOUD

Структура кокаинового облака

Cocaine Cloud

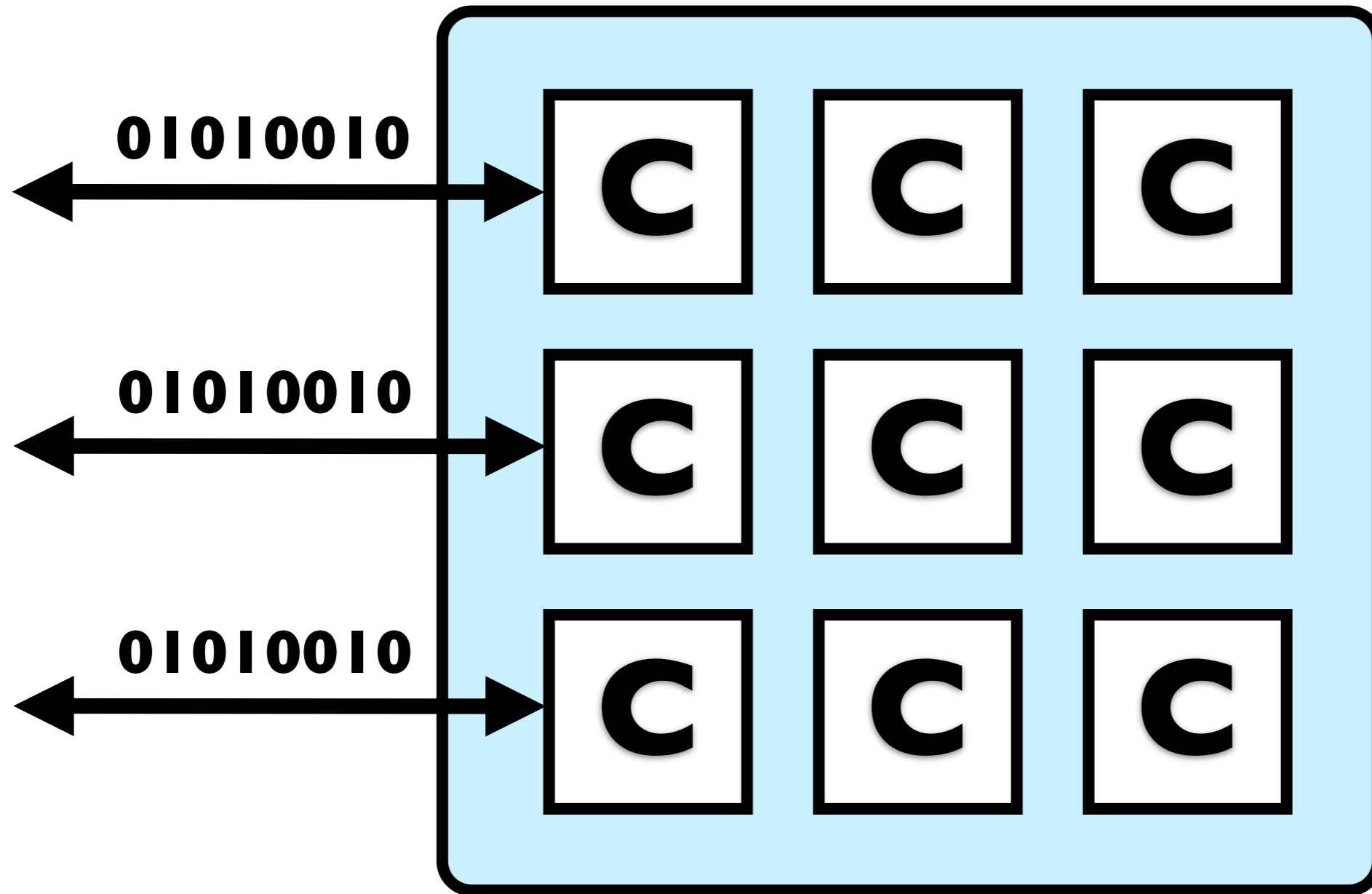

Структура кокаинового облака

Clients

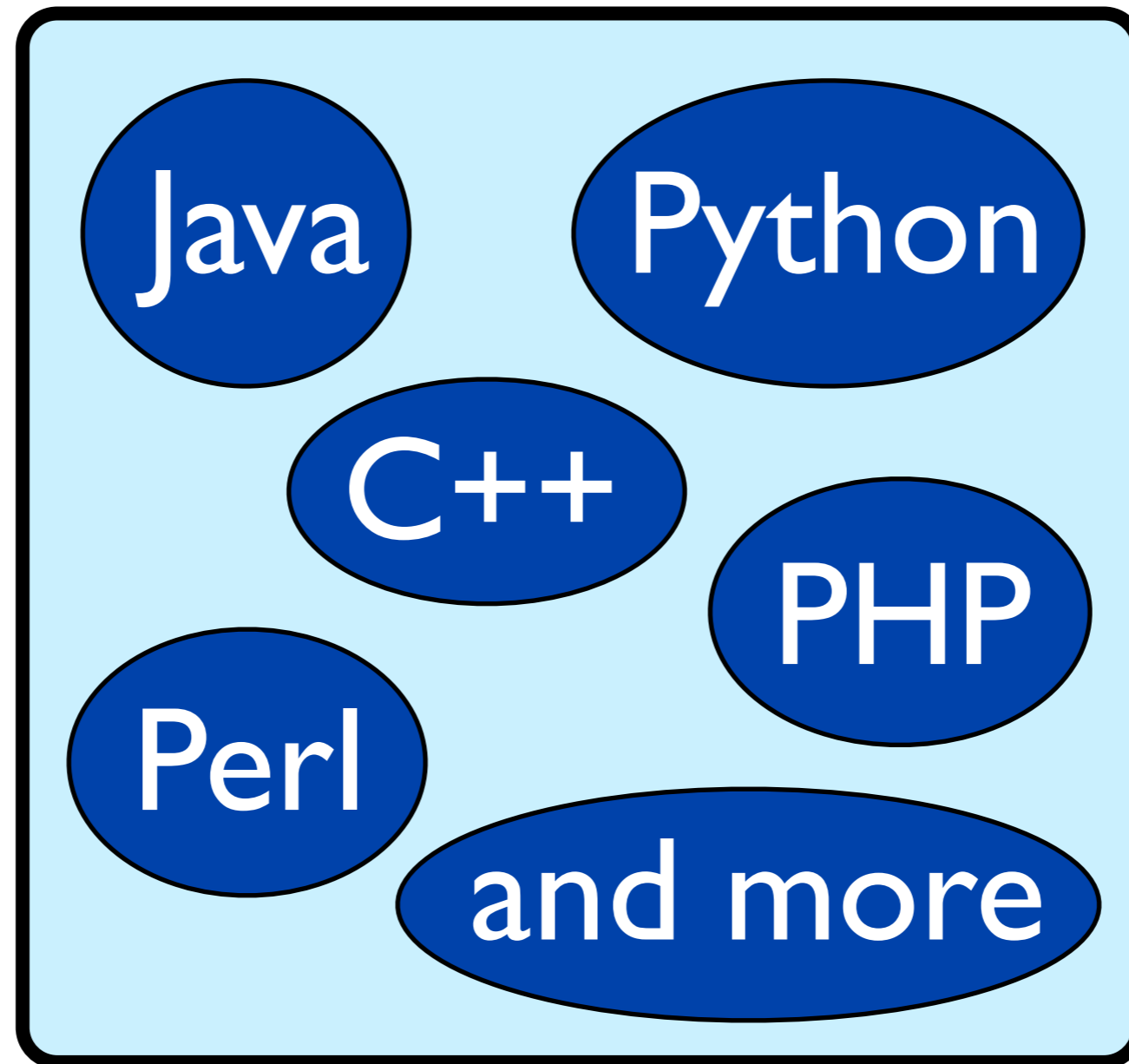

Структура кокаинового облака

Клиенты

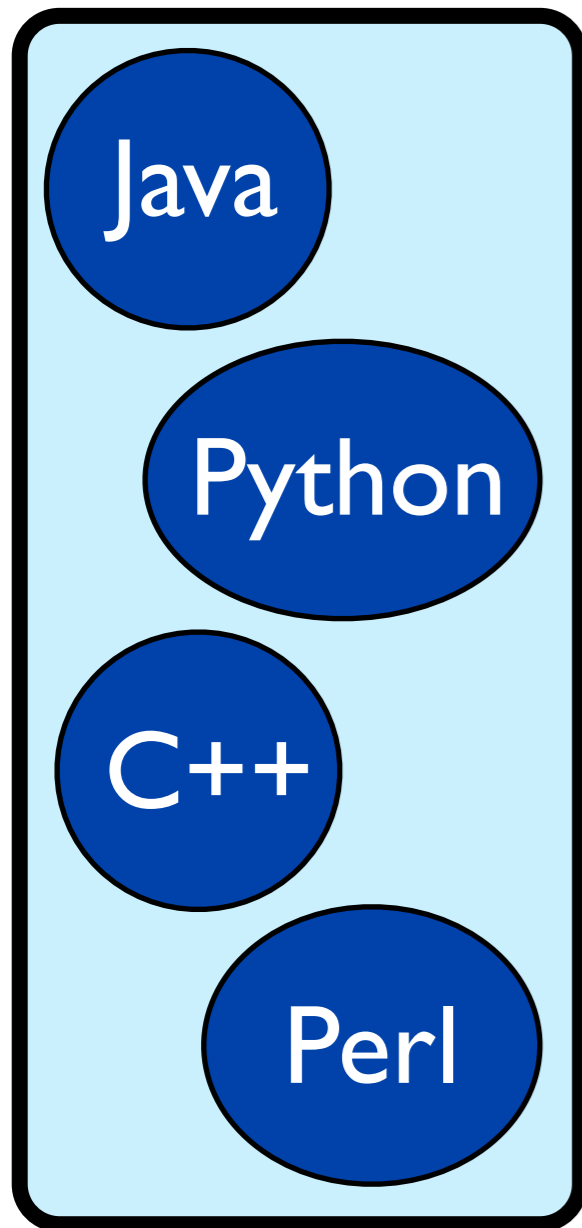

Cocaine

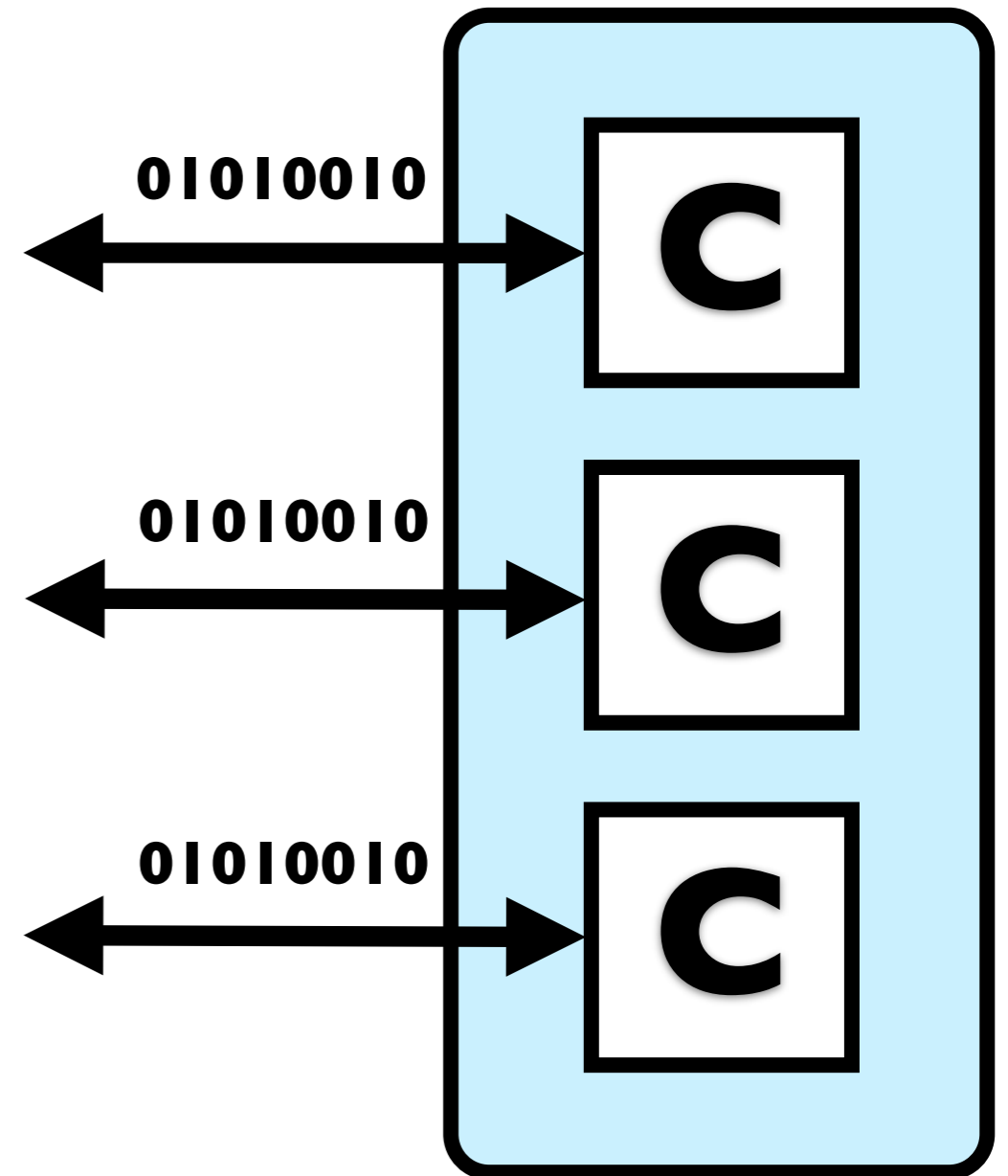

Задача

Как максимально быстро и надёжно доставлять сообщения?

О чём речь?

**Cocaine Dealer — точка
входа в облако.**

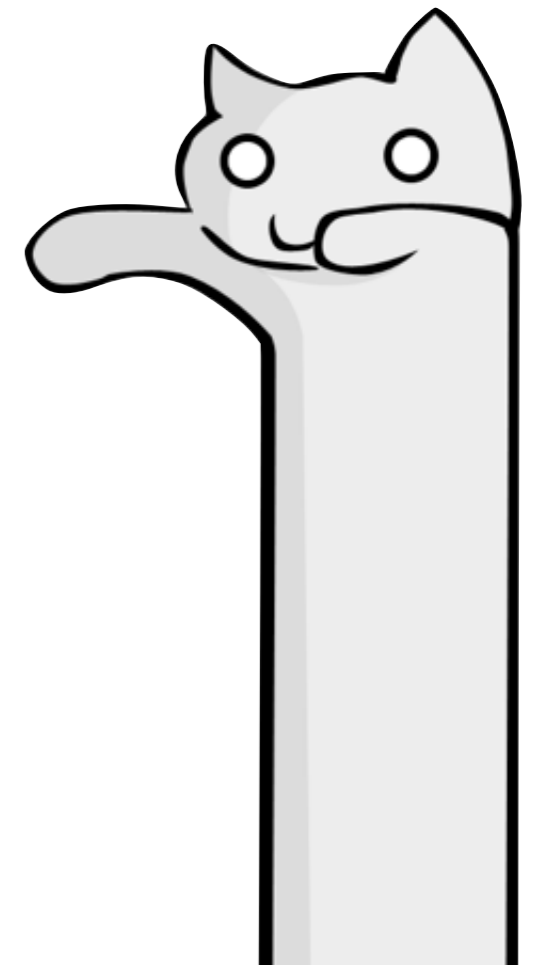

Структура кокаинового облака

Клиенты

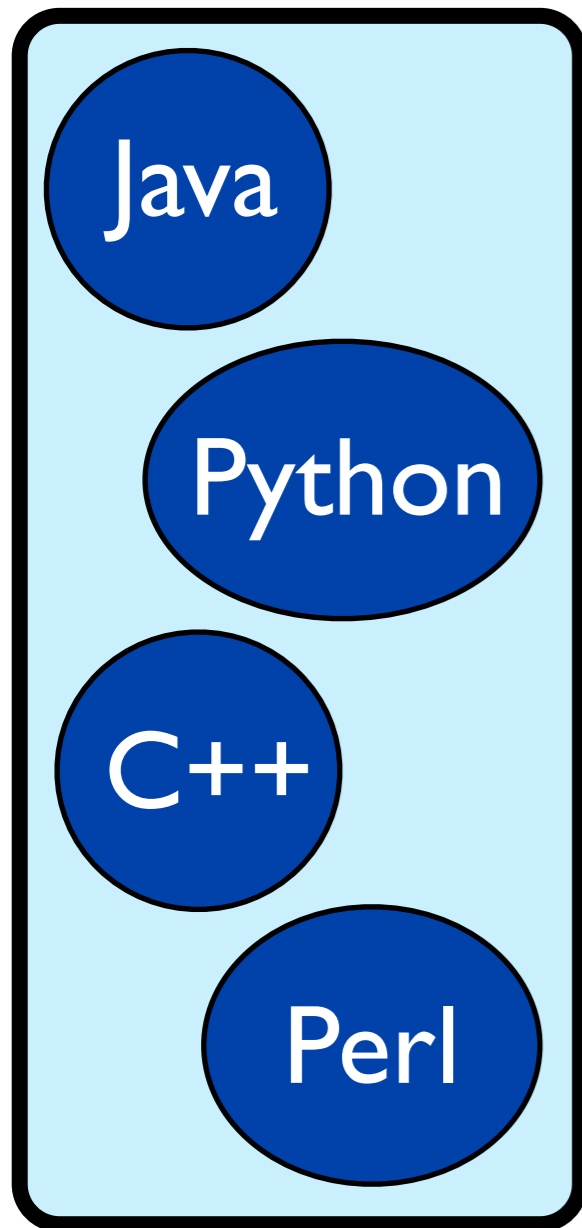

Cocaine

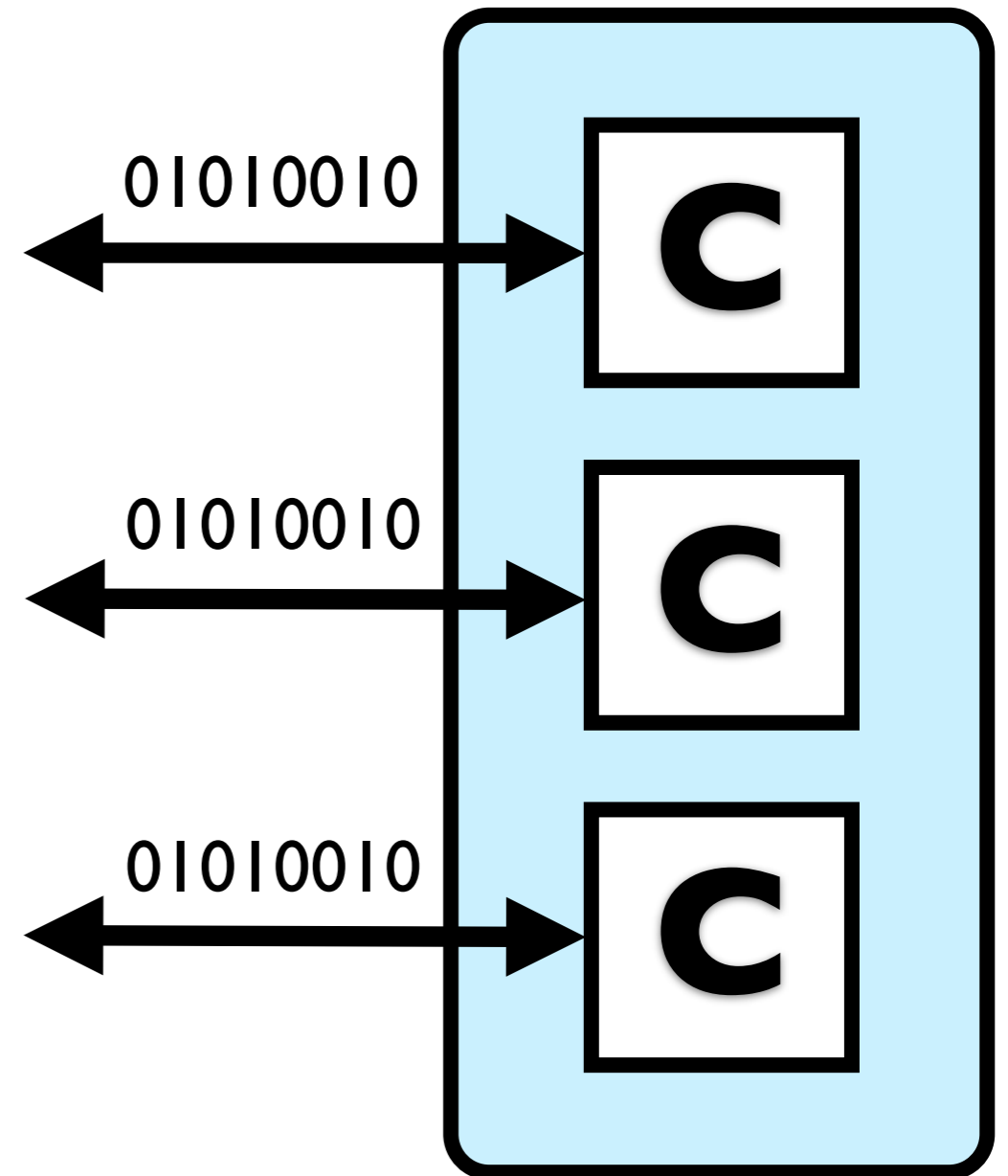

Структура кокаинового облака

Клиенты

Dealer

Cocaine

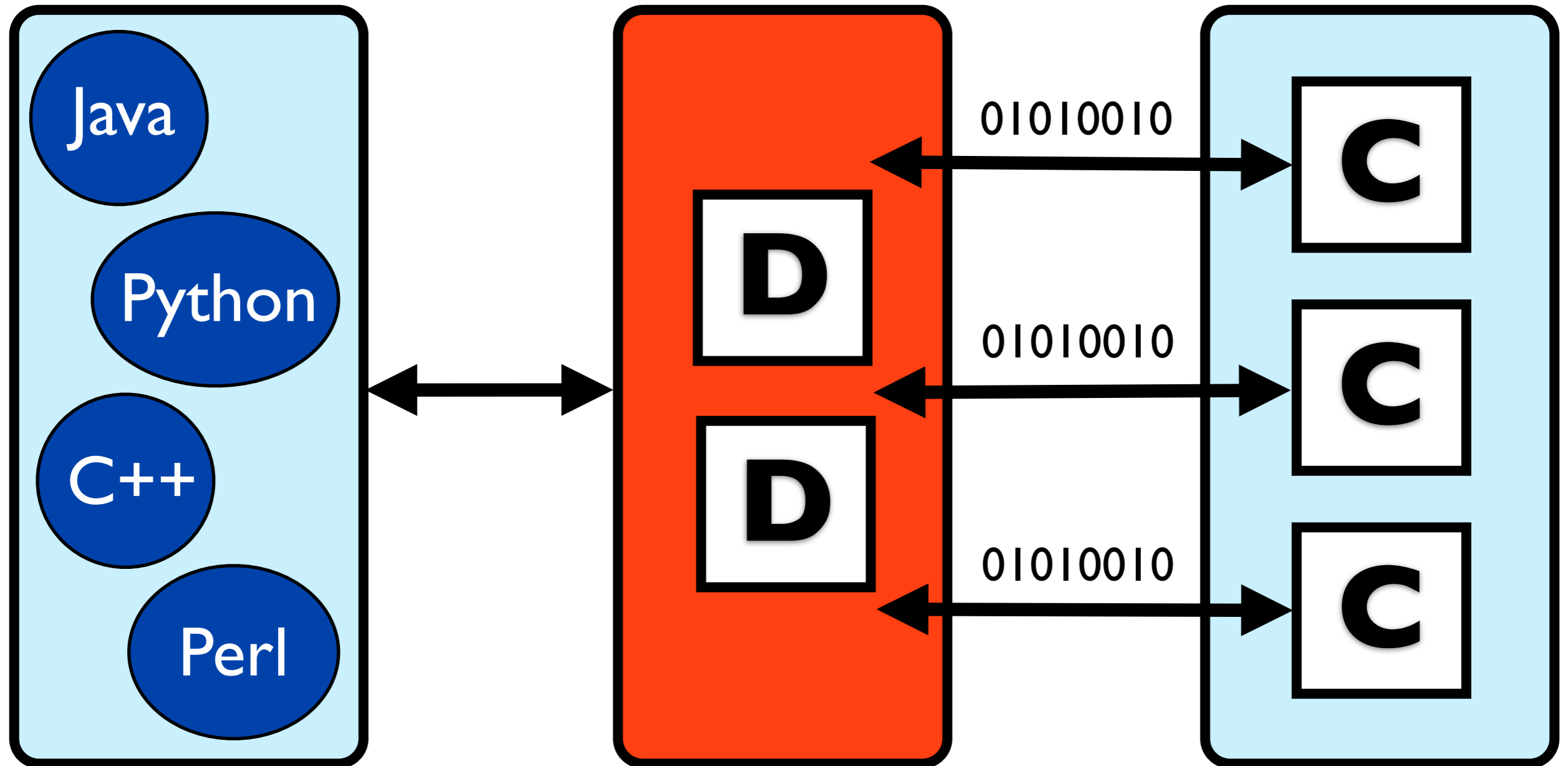

С чем мы имеем дело?





server's down

Она просто взорвалась или типа того

Как растёт инфраструктура?

Серверы

Балансировщик

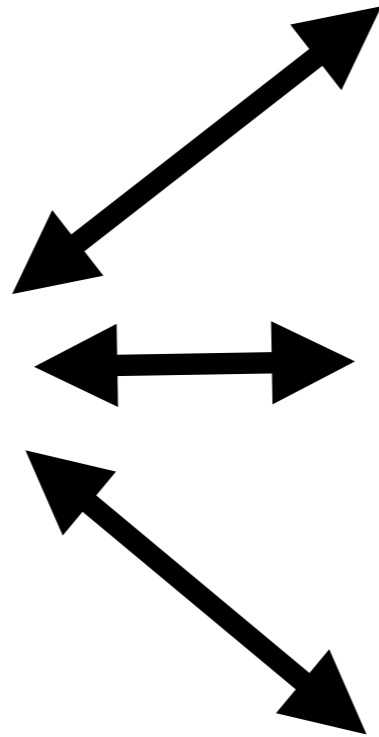



ВЫЛЕЗАЙ, ПРИЕХАЛИ

Как растёт инфраструктура?

Балансировщик

Серверы

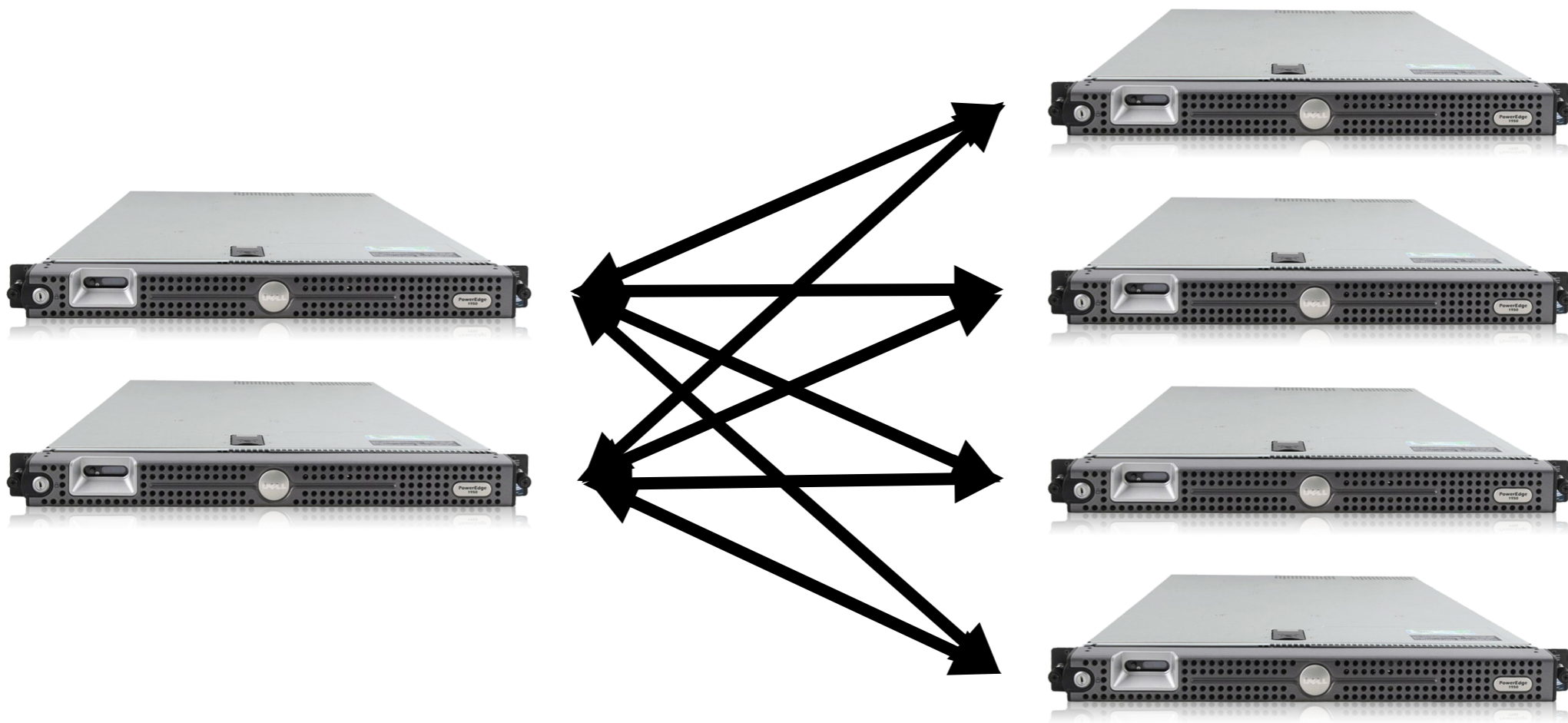



17

Мелкие неприятности в ДЦ

Как растёт инфраструктура?

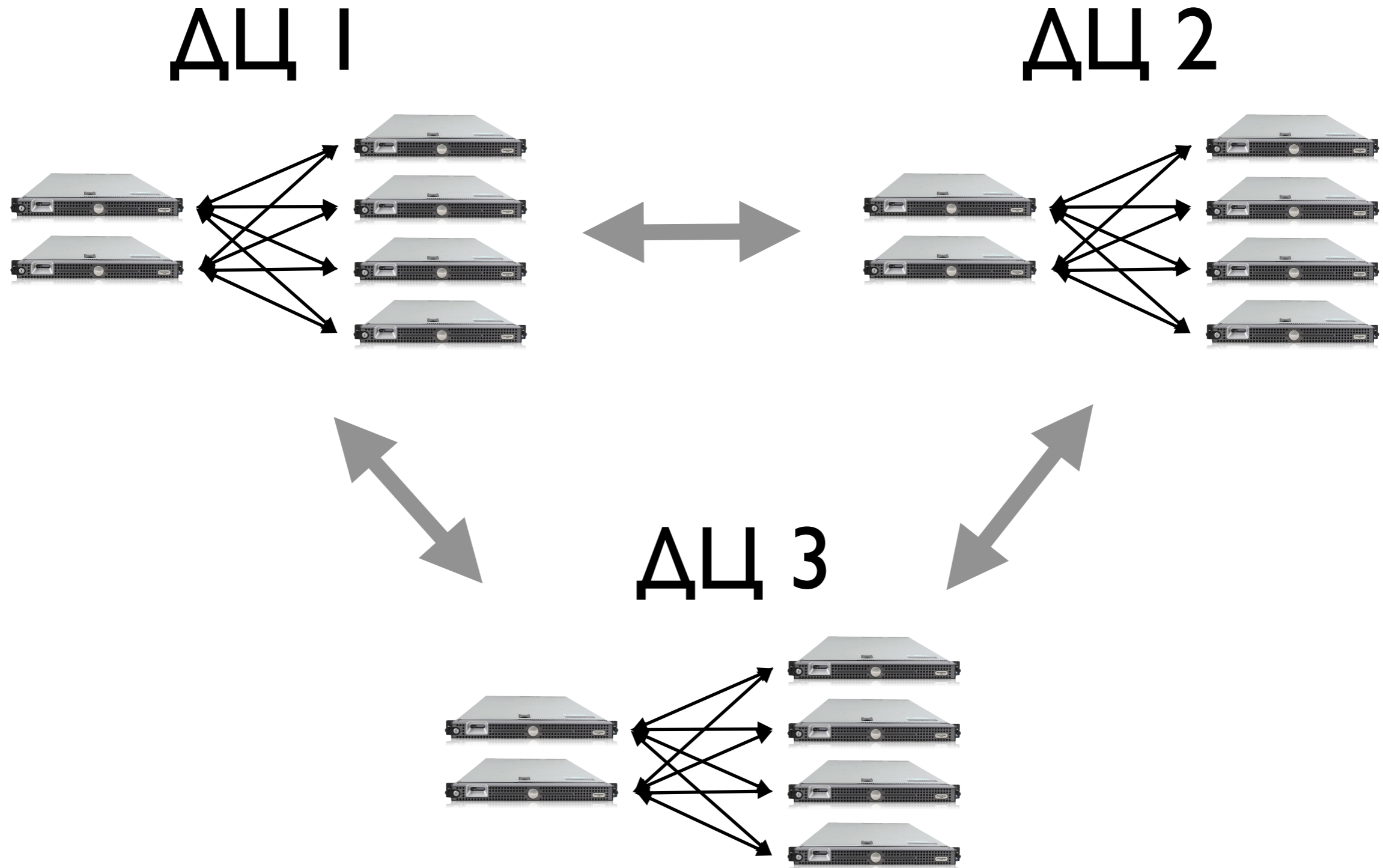

Задача

Как максимально быстро и надёжно доставлять сообщения?



1. Performance

О чём речь?

Cocaine Dealer — точка
входа в облако.

Это библиотека
написанная на C++

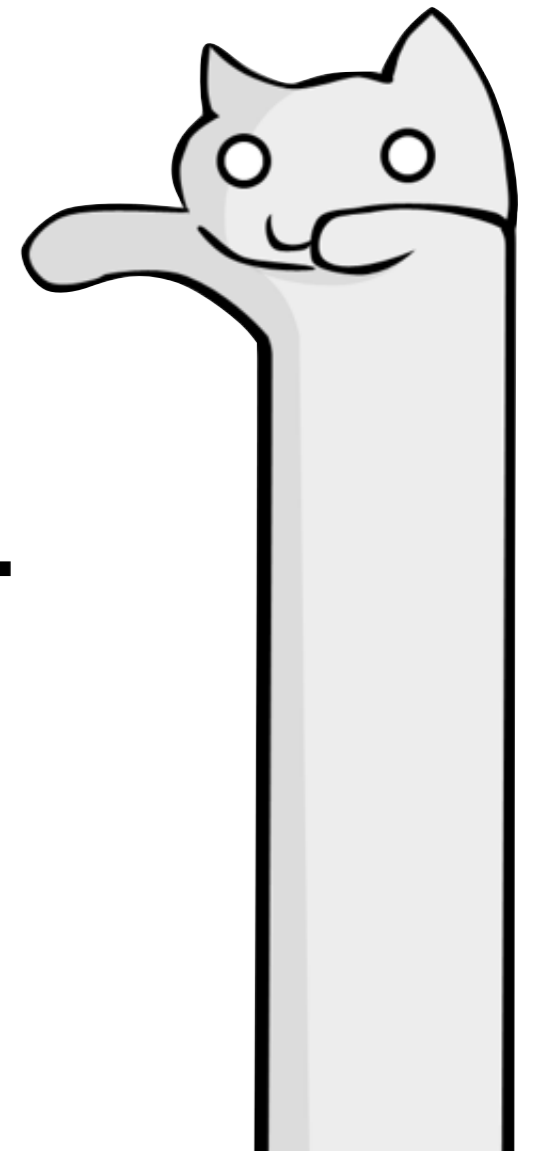

Логическая структура облака

Клиенты

Dealer

Cocaine

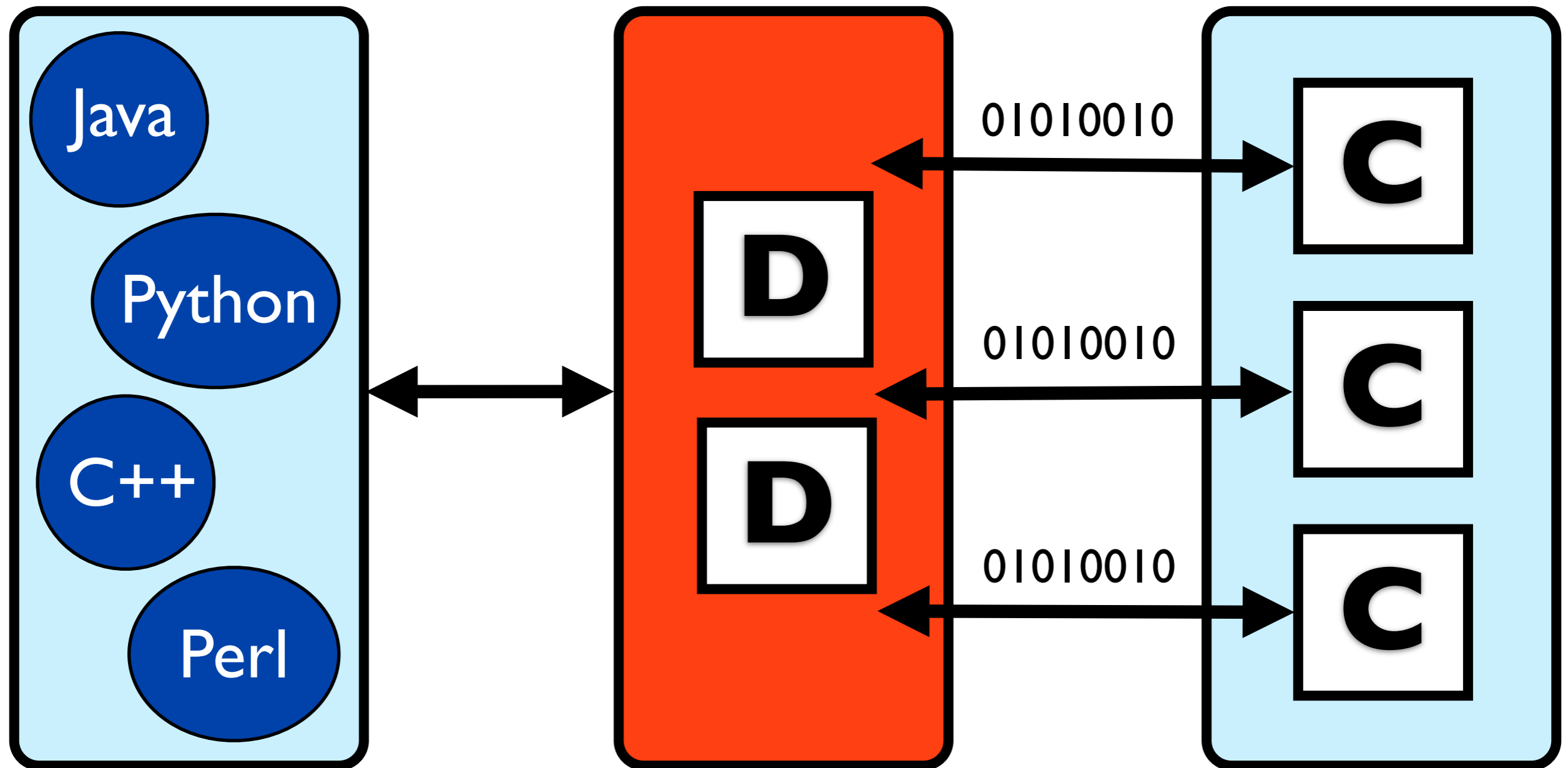

Физическая структура облака

Клиенты

Dealer

Cocaine

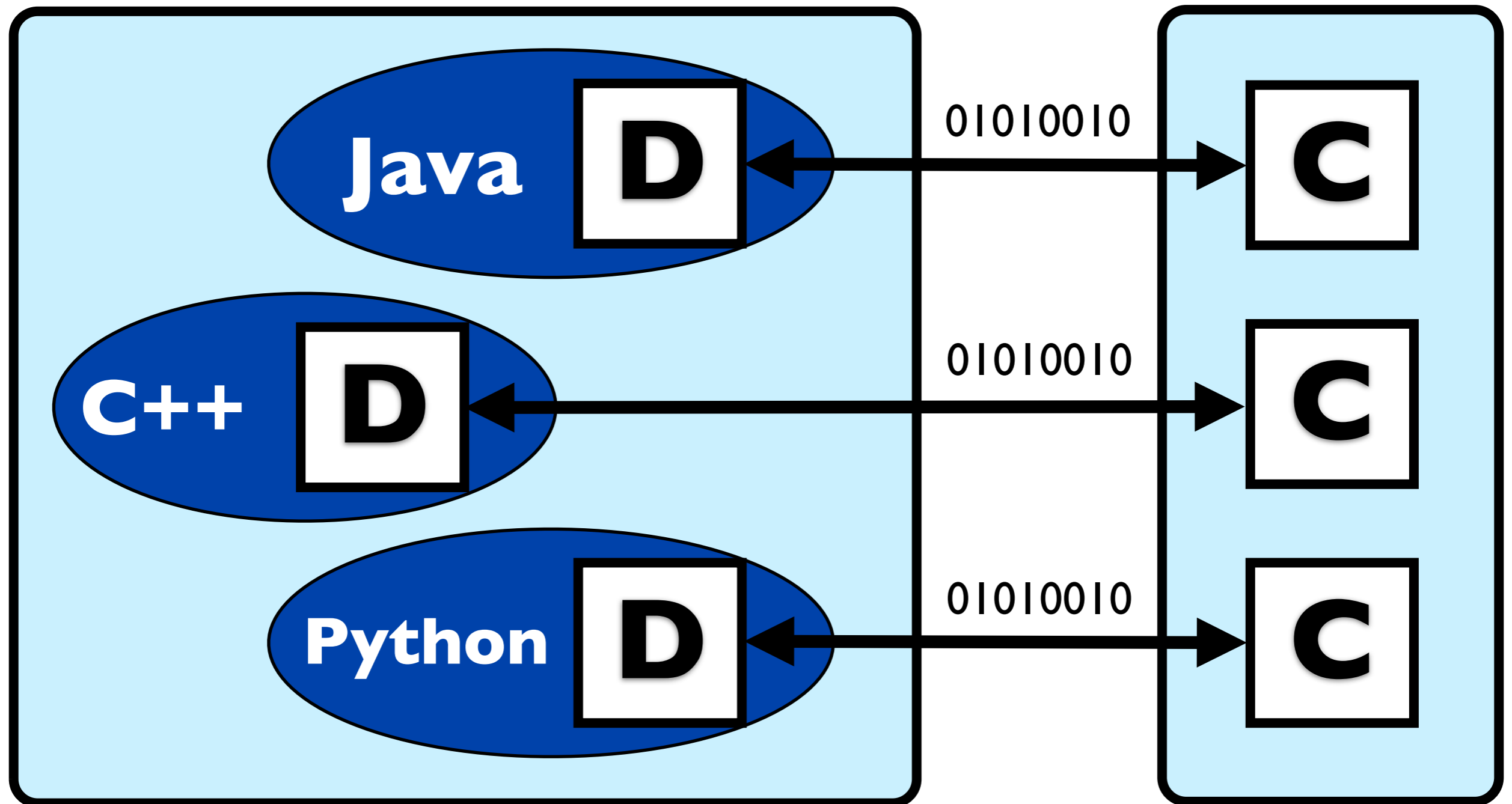



2. Cloud awareness

Cloud awareness

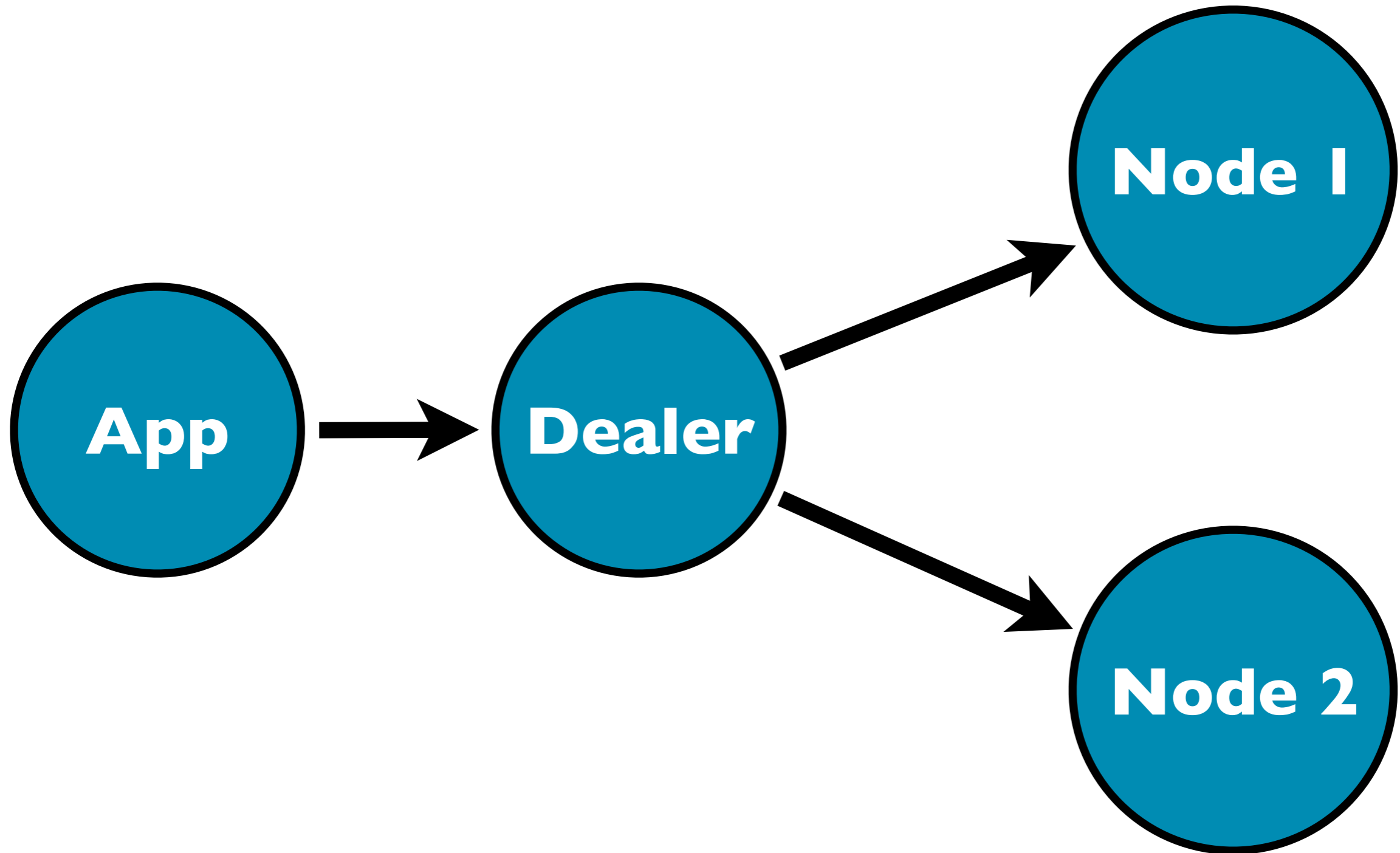

Cloud awareness

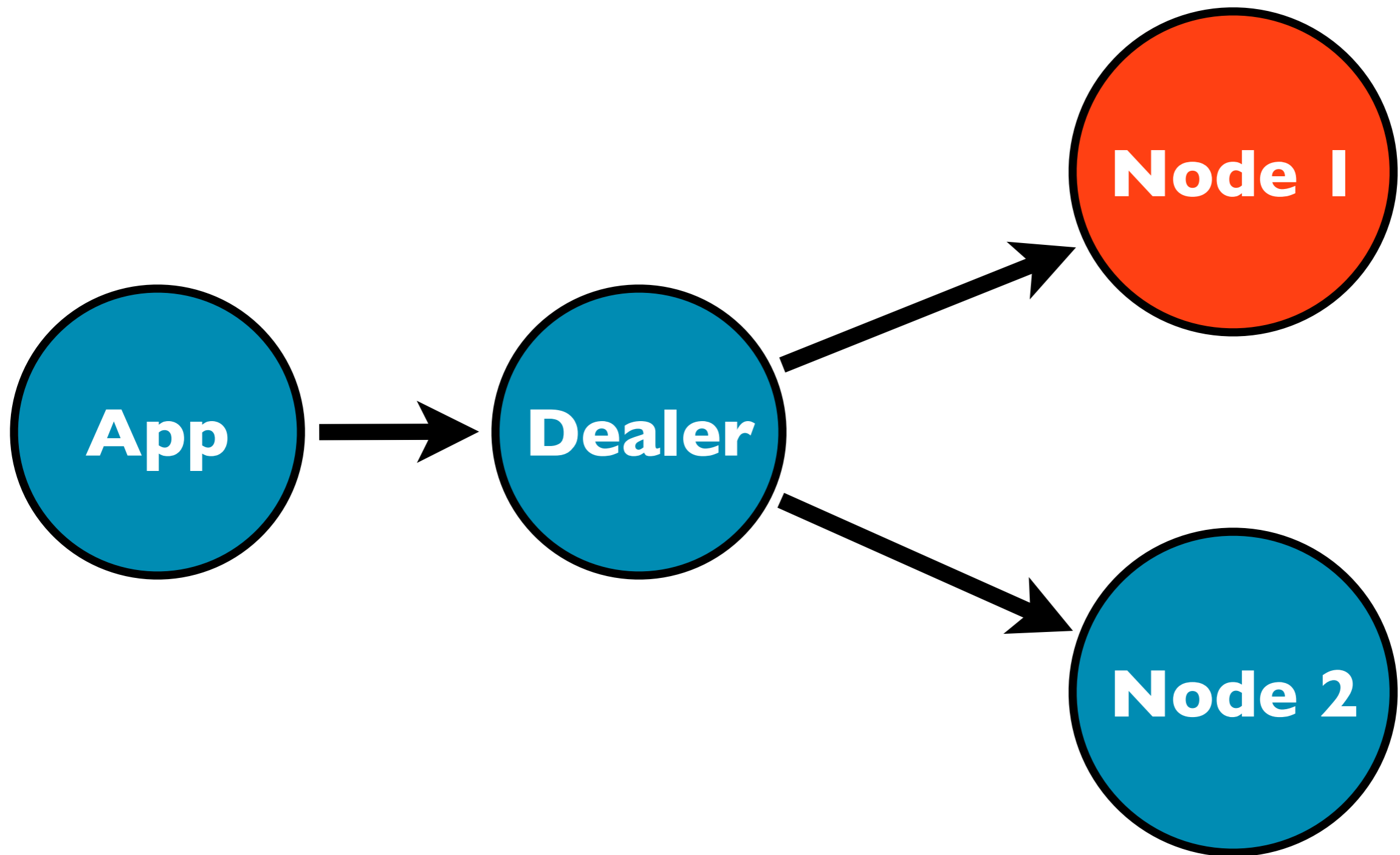

Cloud awareness

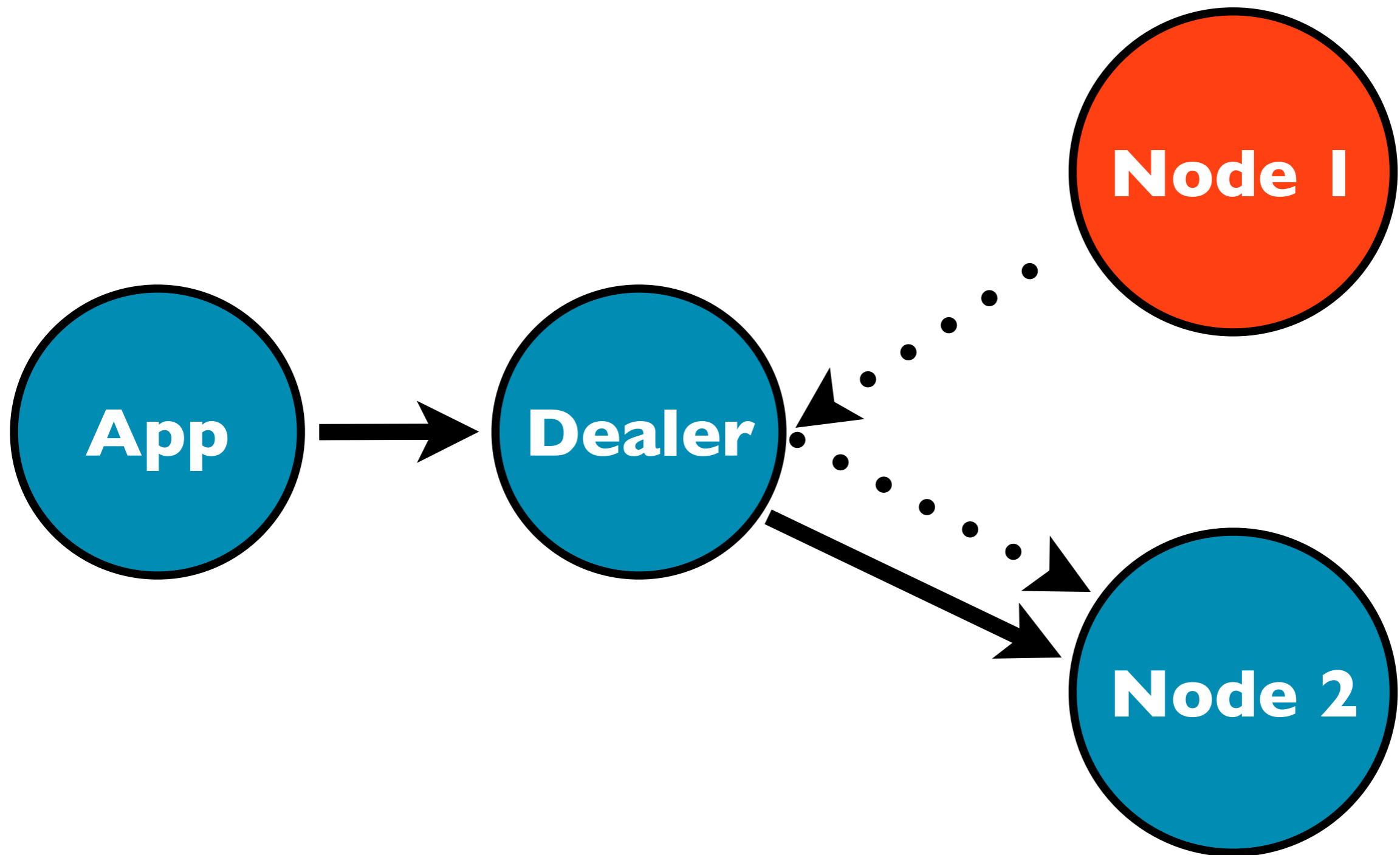



3. Always ON

Always ON

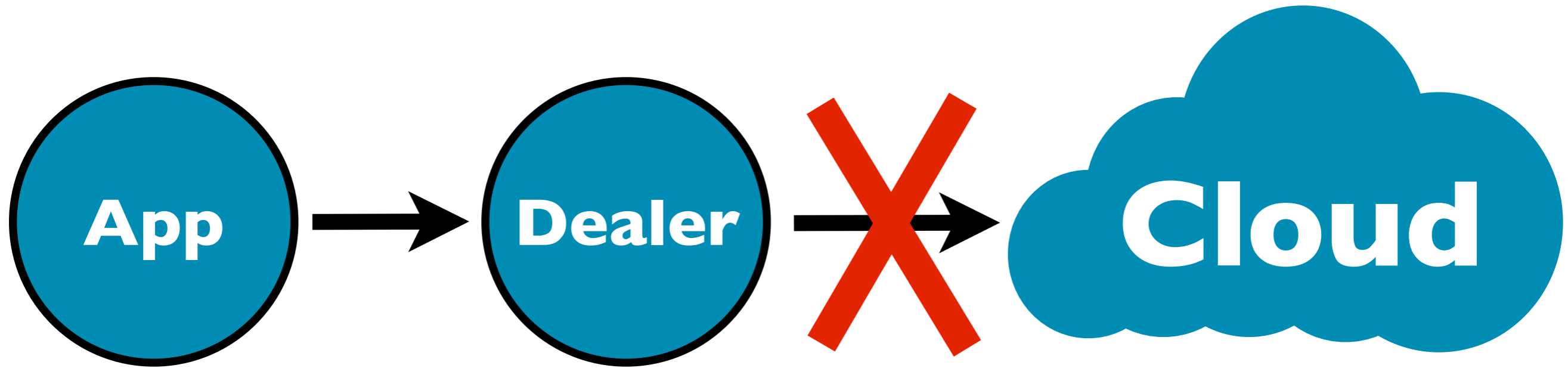

Always ON

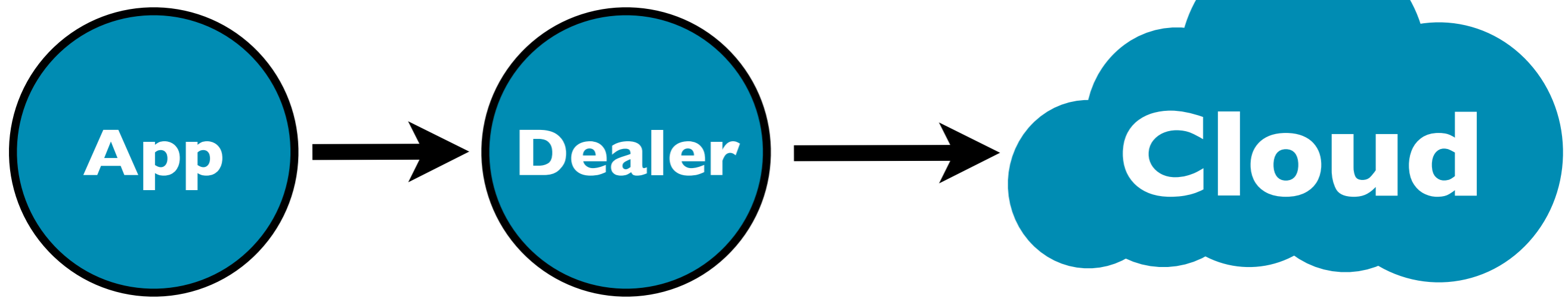



4. Fine tuning

Политики маршрутизации

- **Deadline**
- **Max retries**
- **Priority**
- **Persistence**
- **etc.**

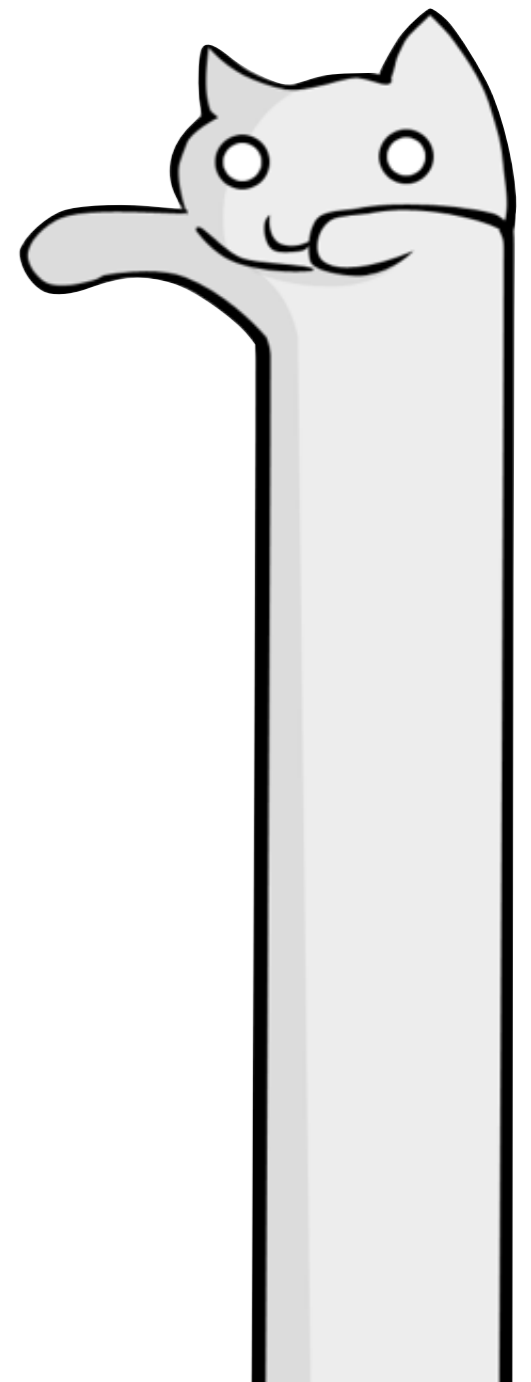



5. Persistent delivery

Persistent delivery

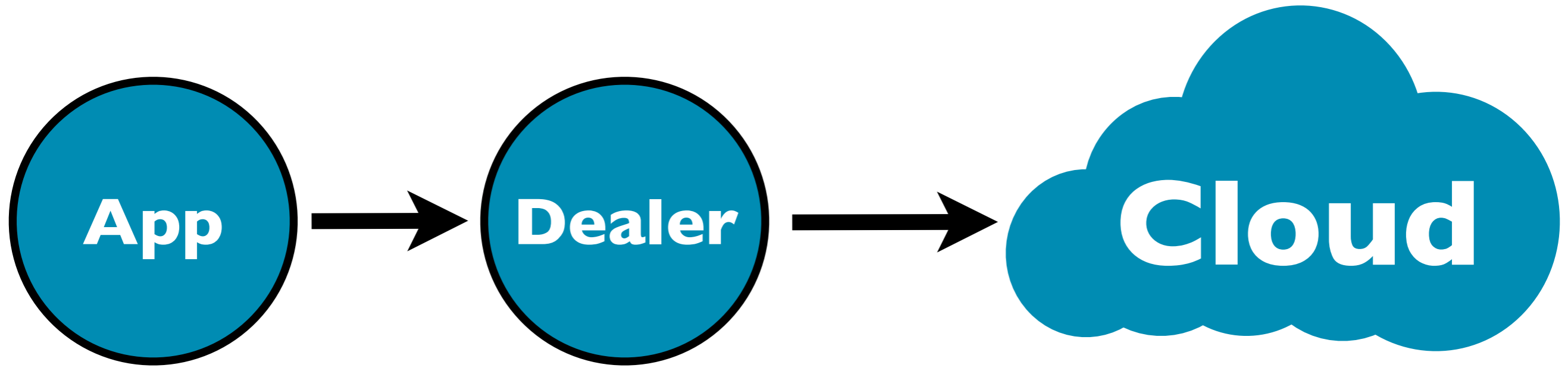

Persistent delivery

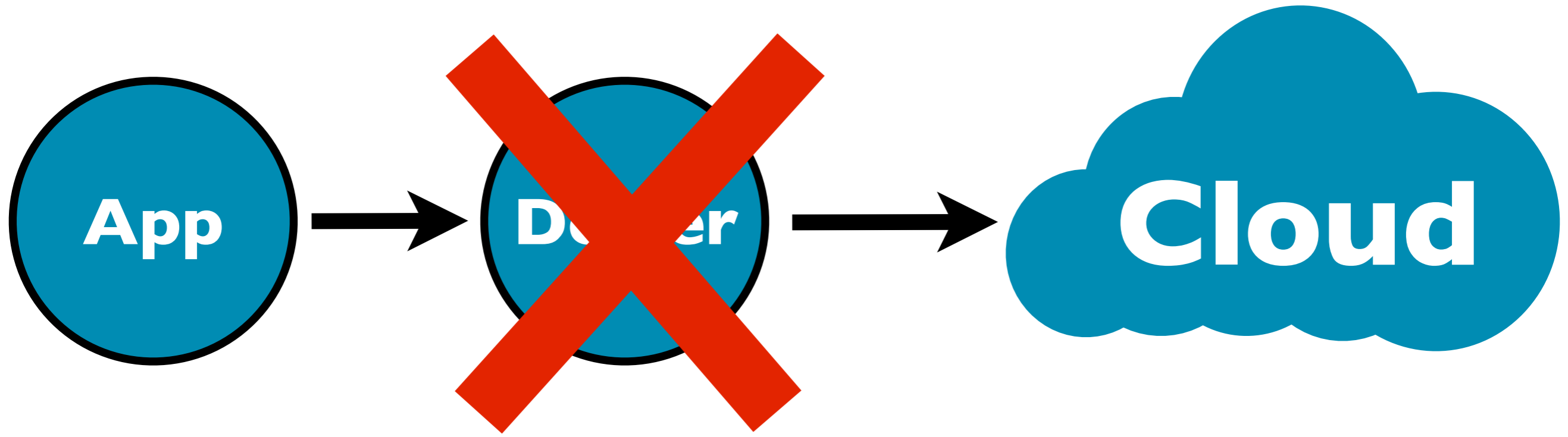

Persistent delivery

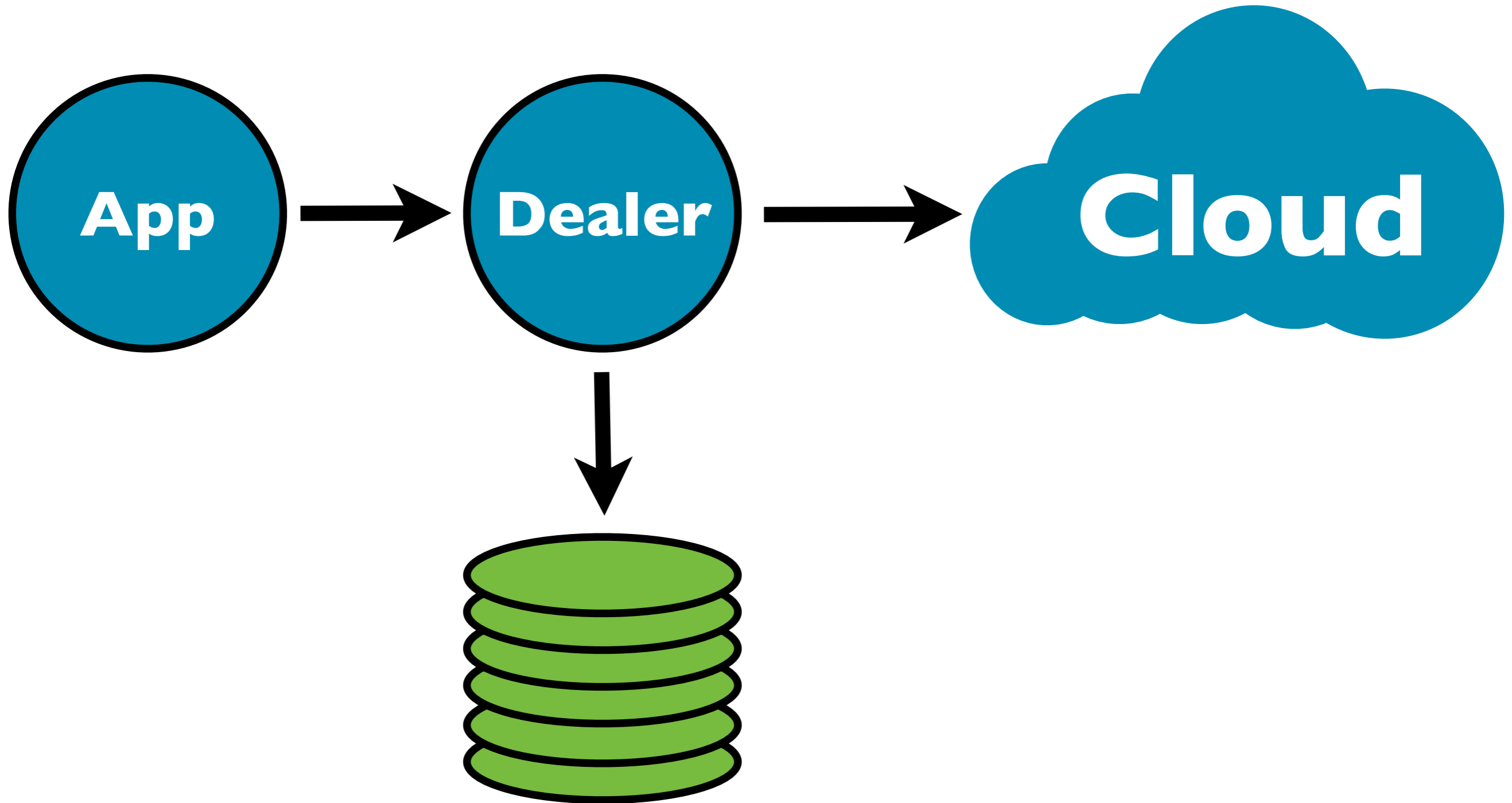

Persistent delivery

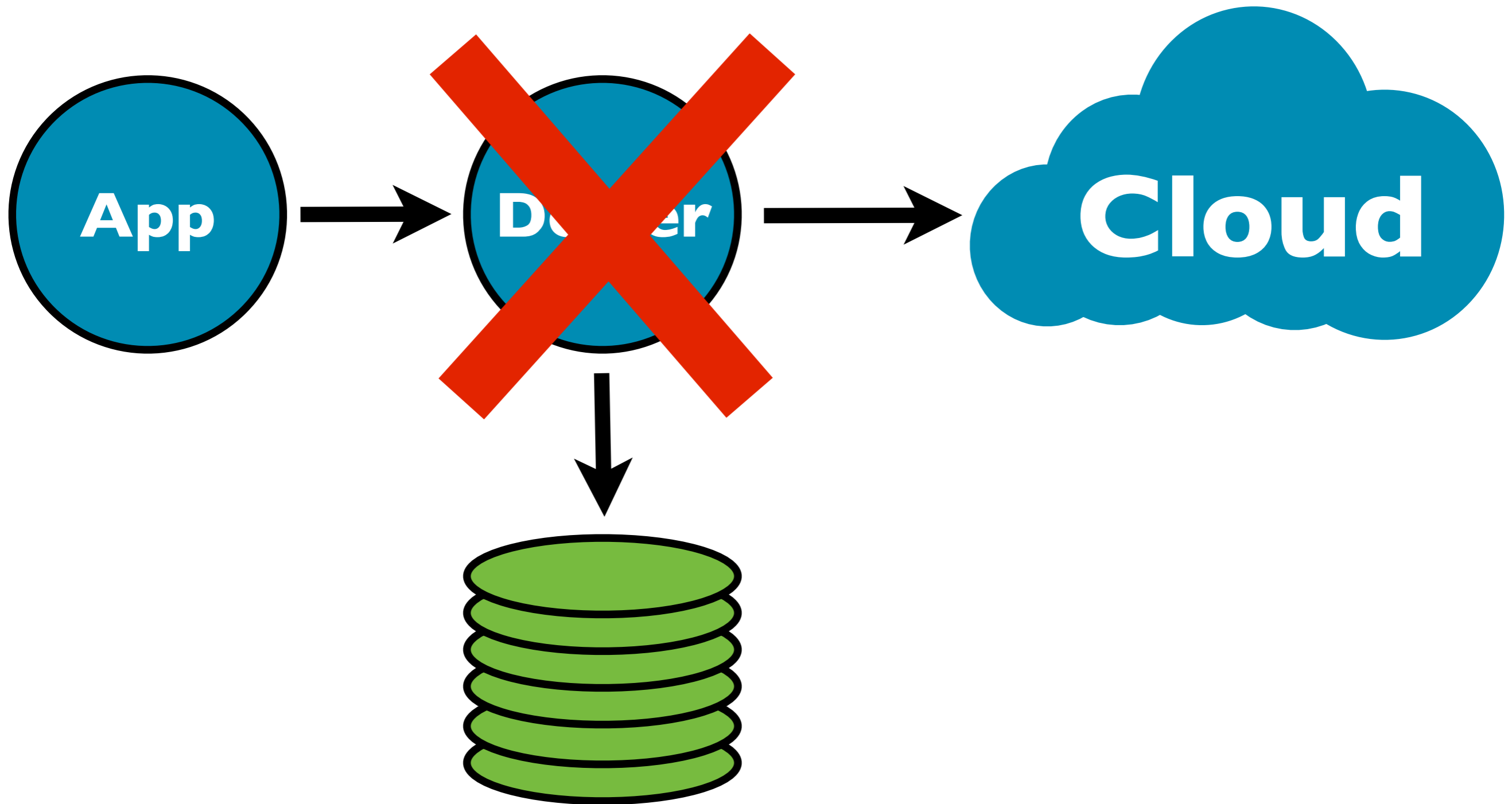

Persistent delivery

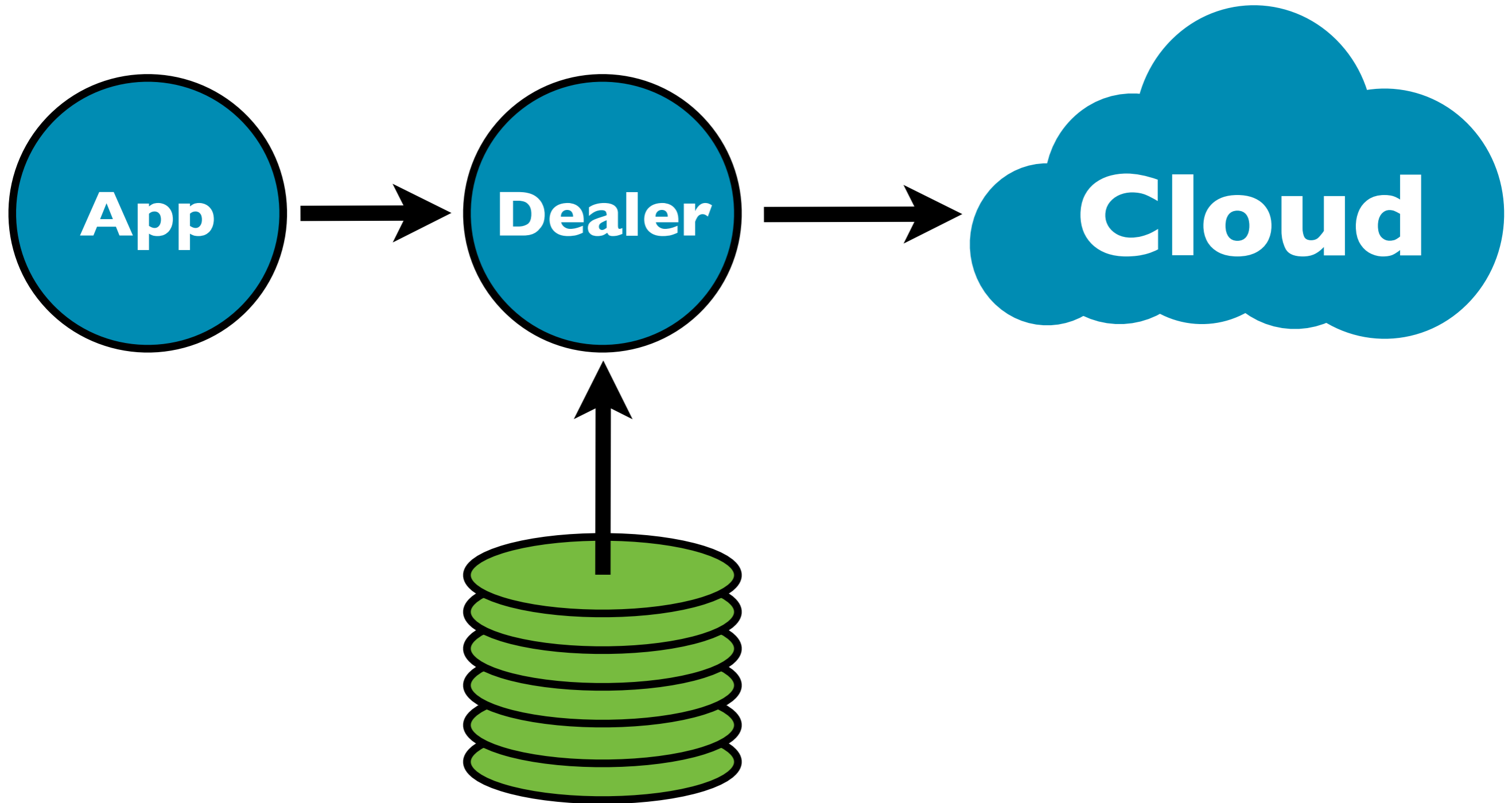



6. Smart balancing

Naive balancing

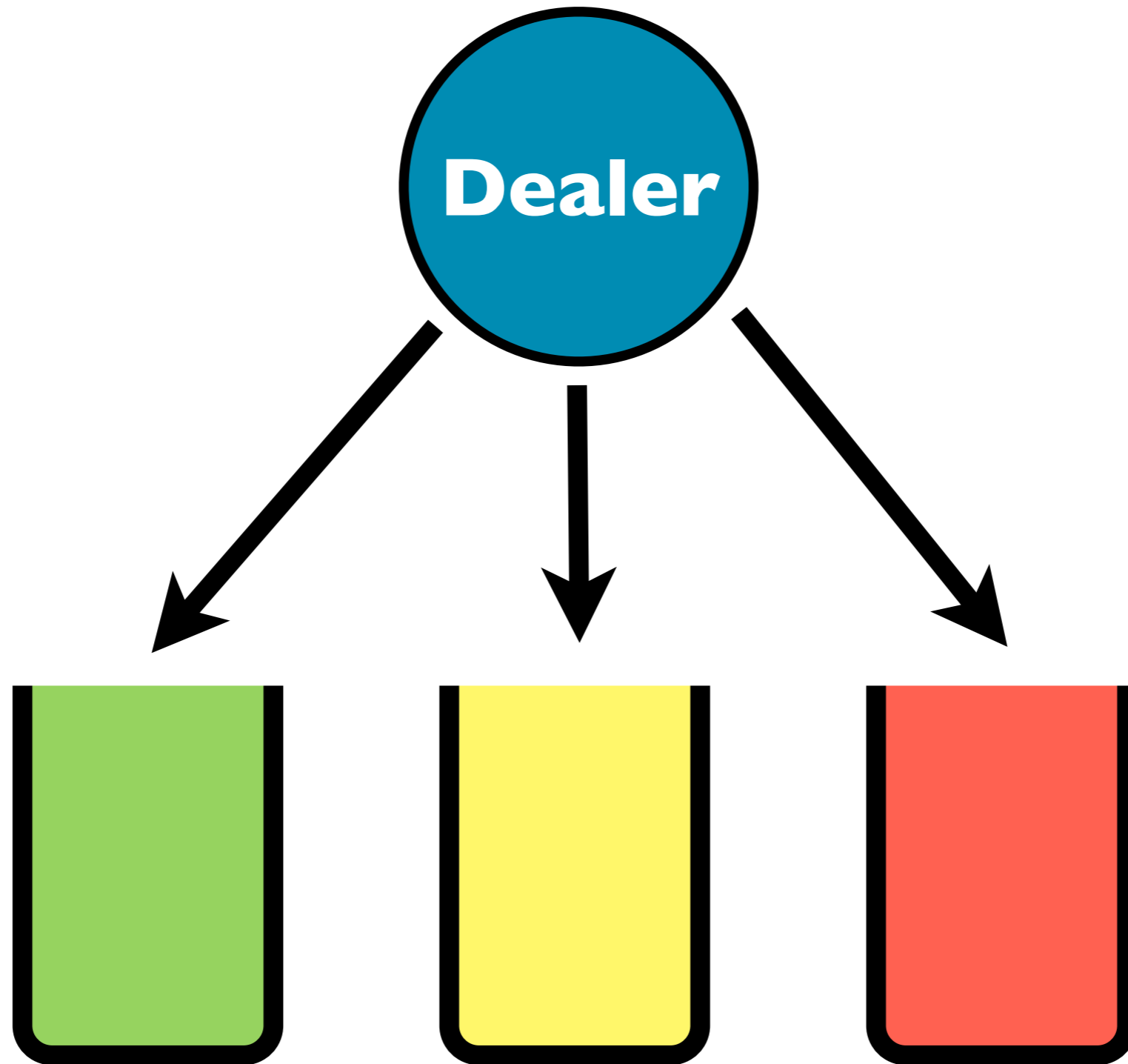

Naive balancing

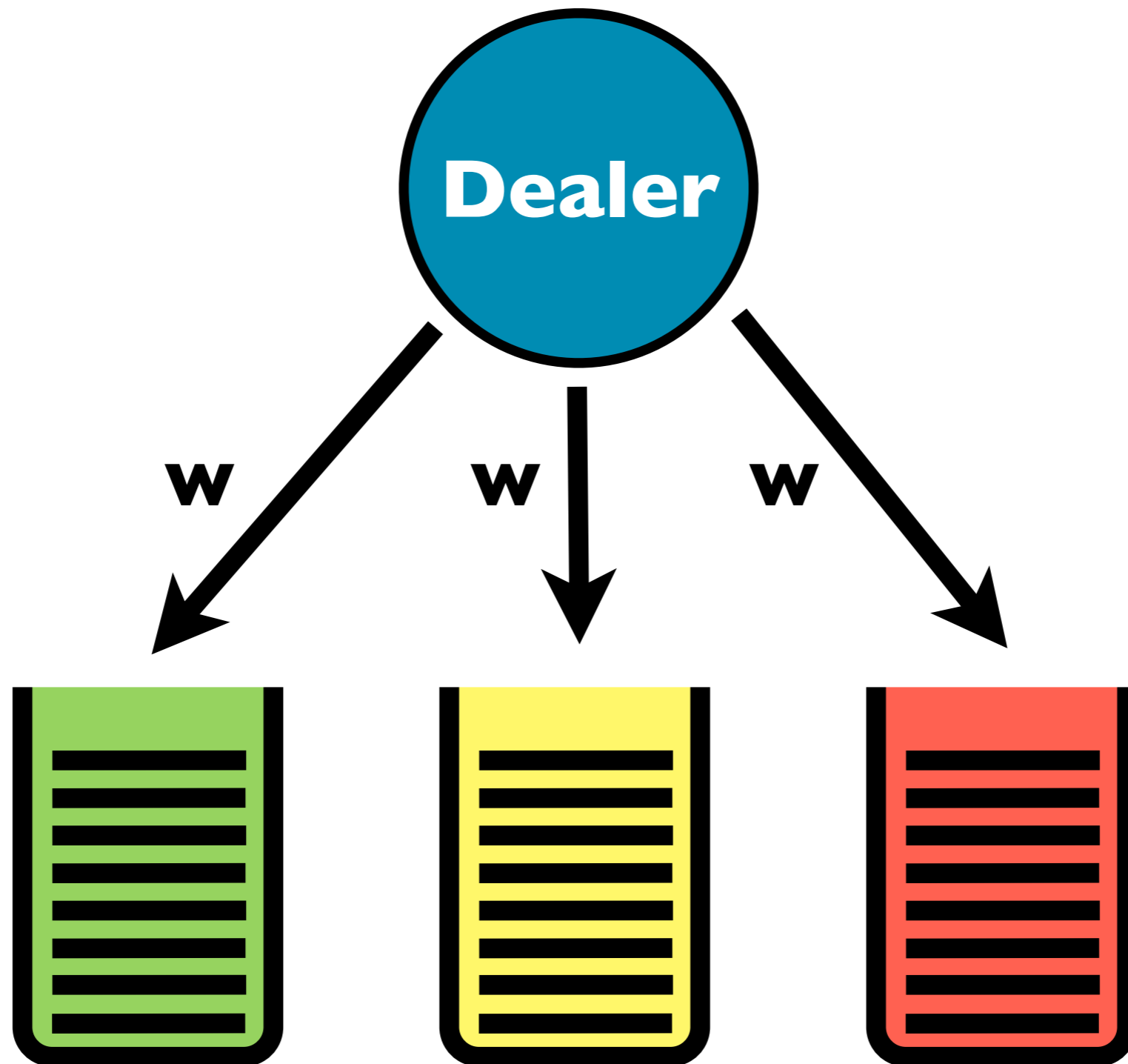

Naive balancing

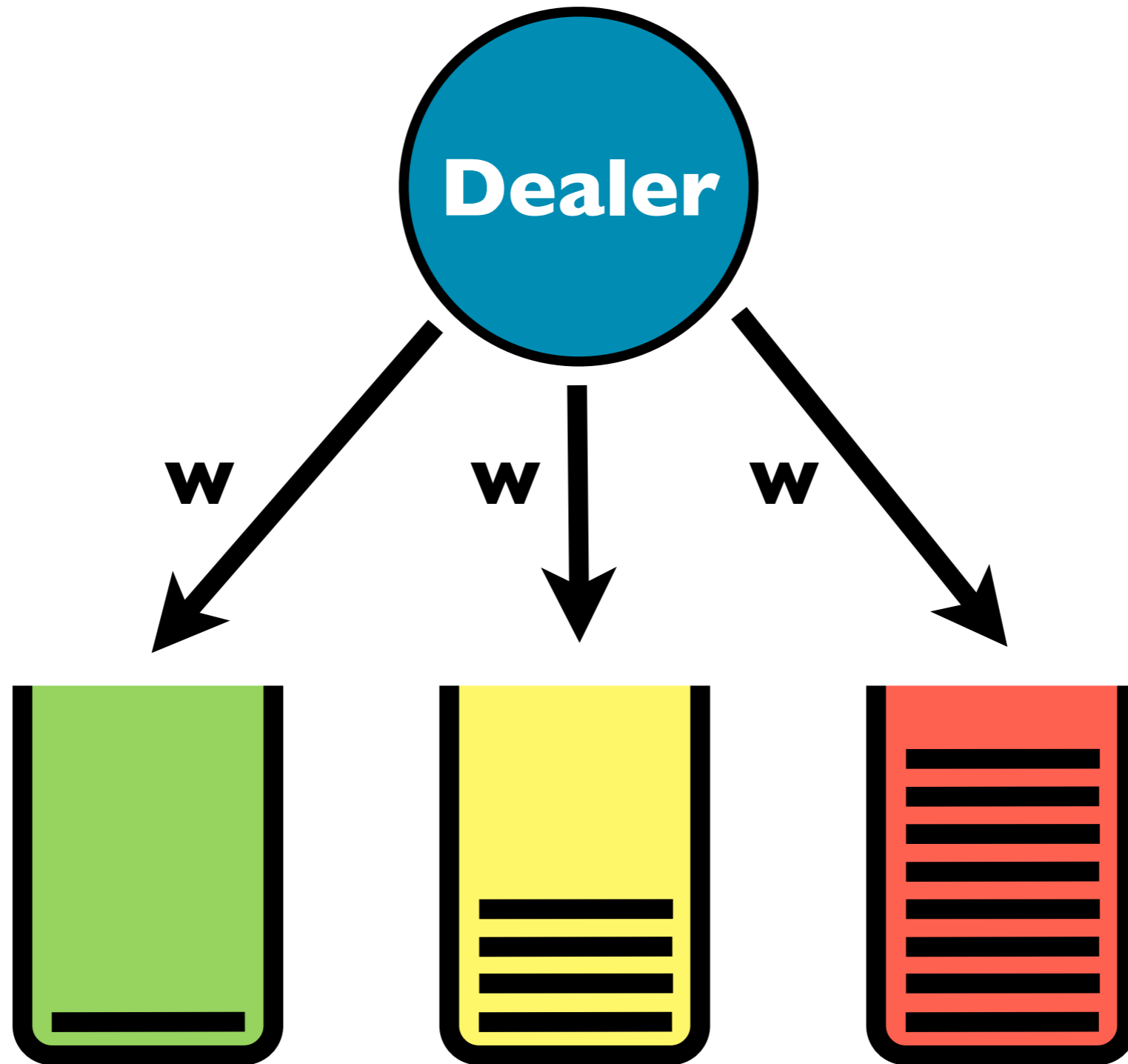

Smart balancing

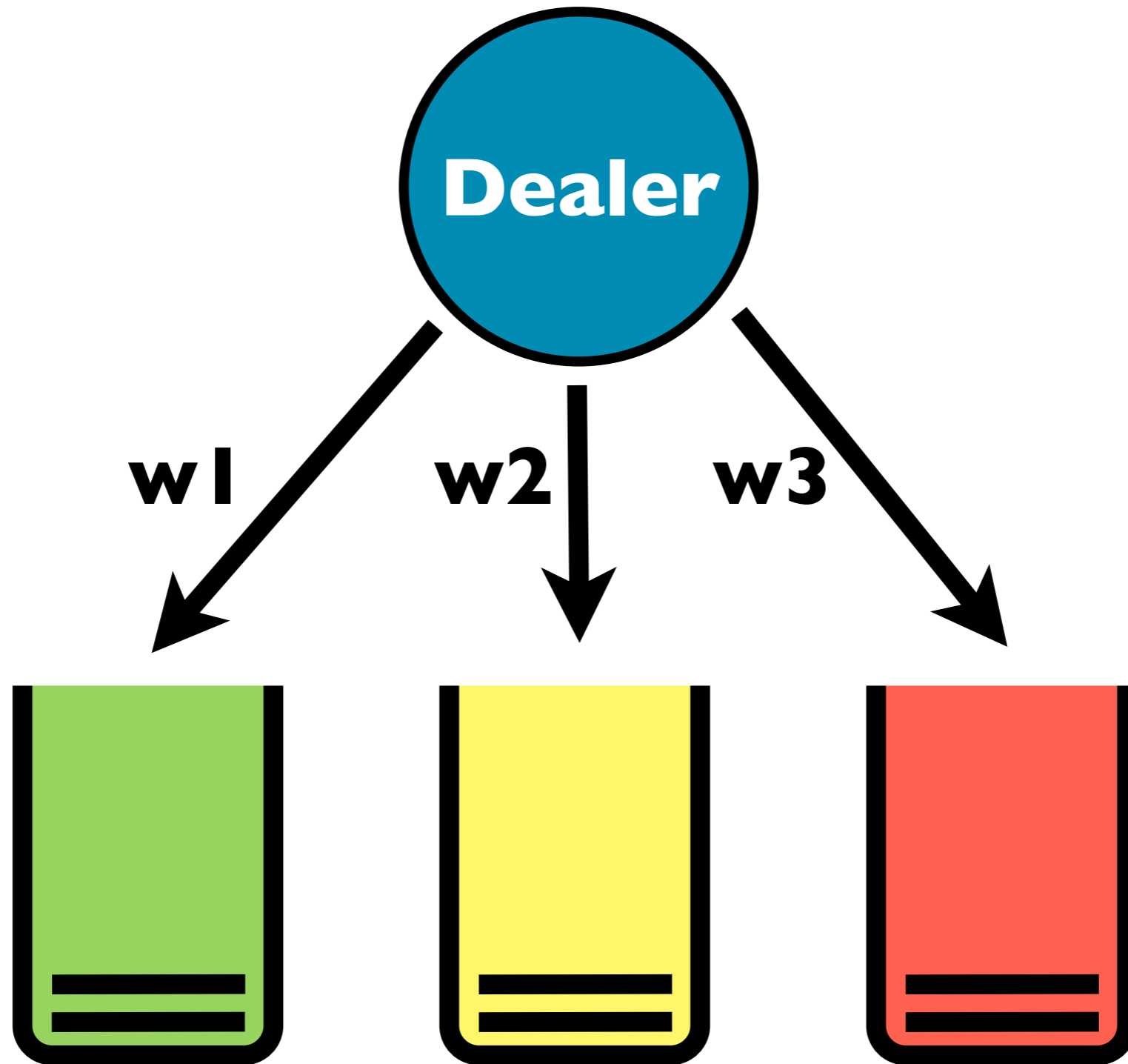



7. Health monitoring

Health monitoring

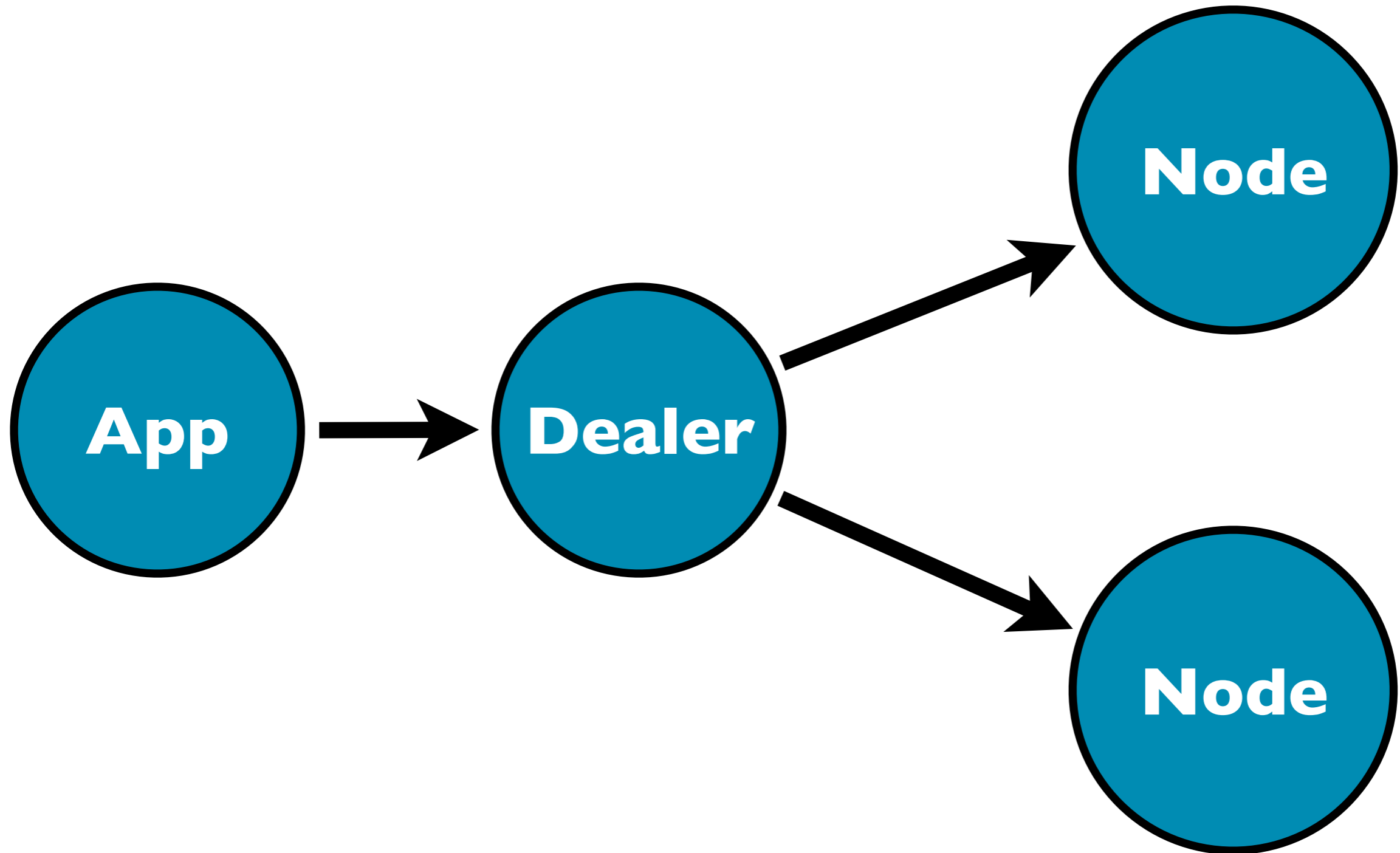

Health monitoring

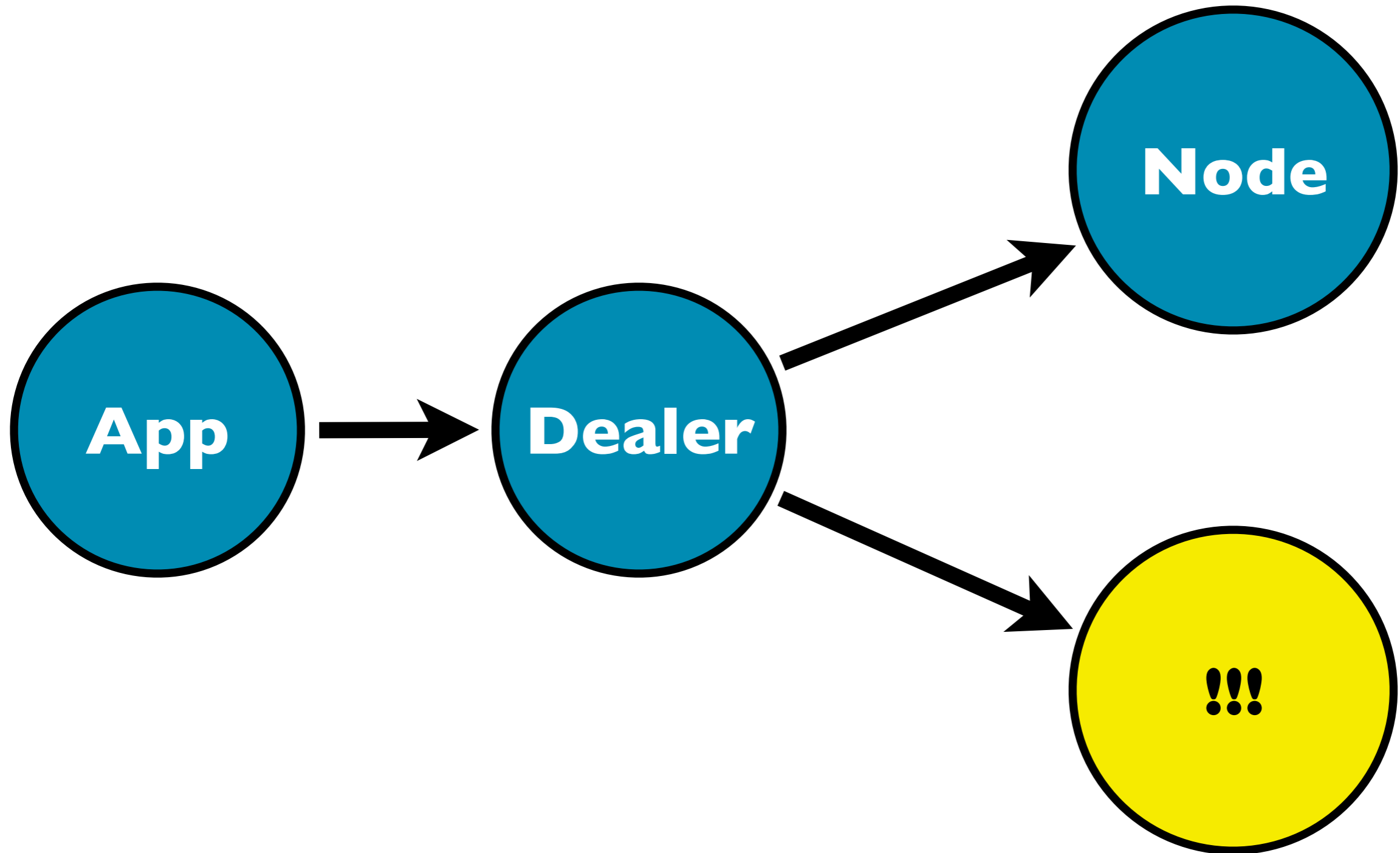

Health monitoring

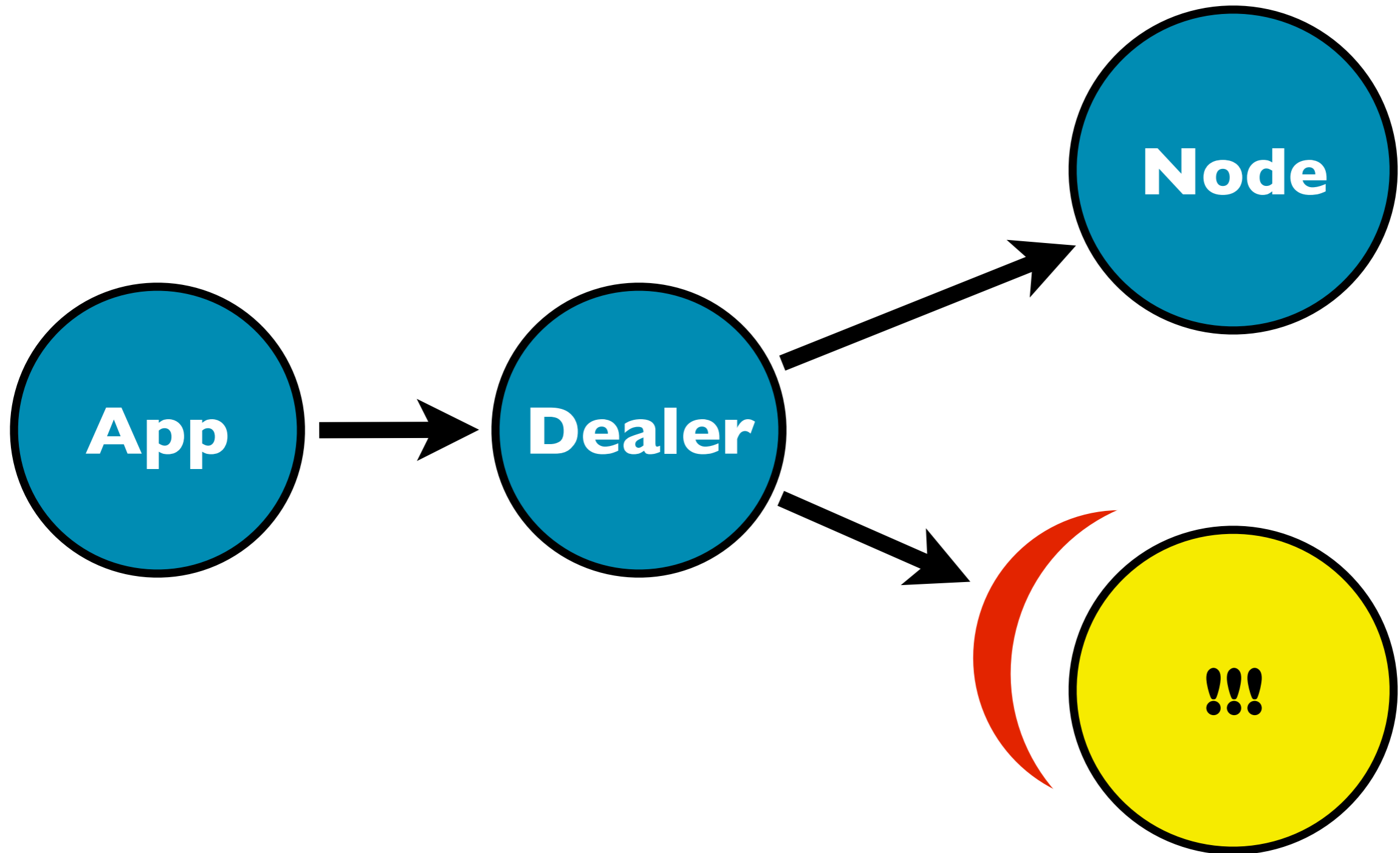

Health monitoring

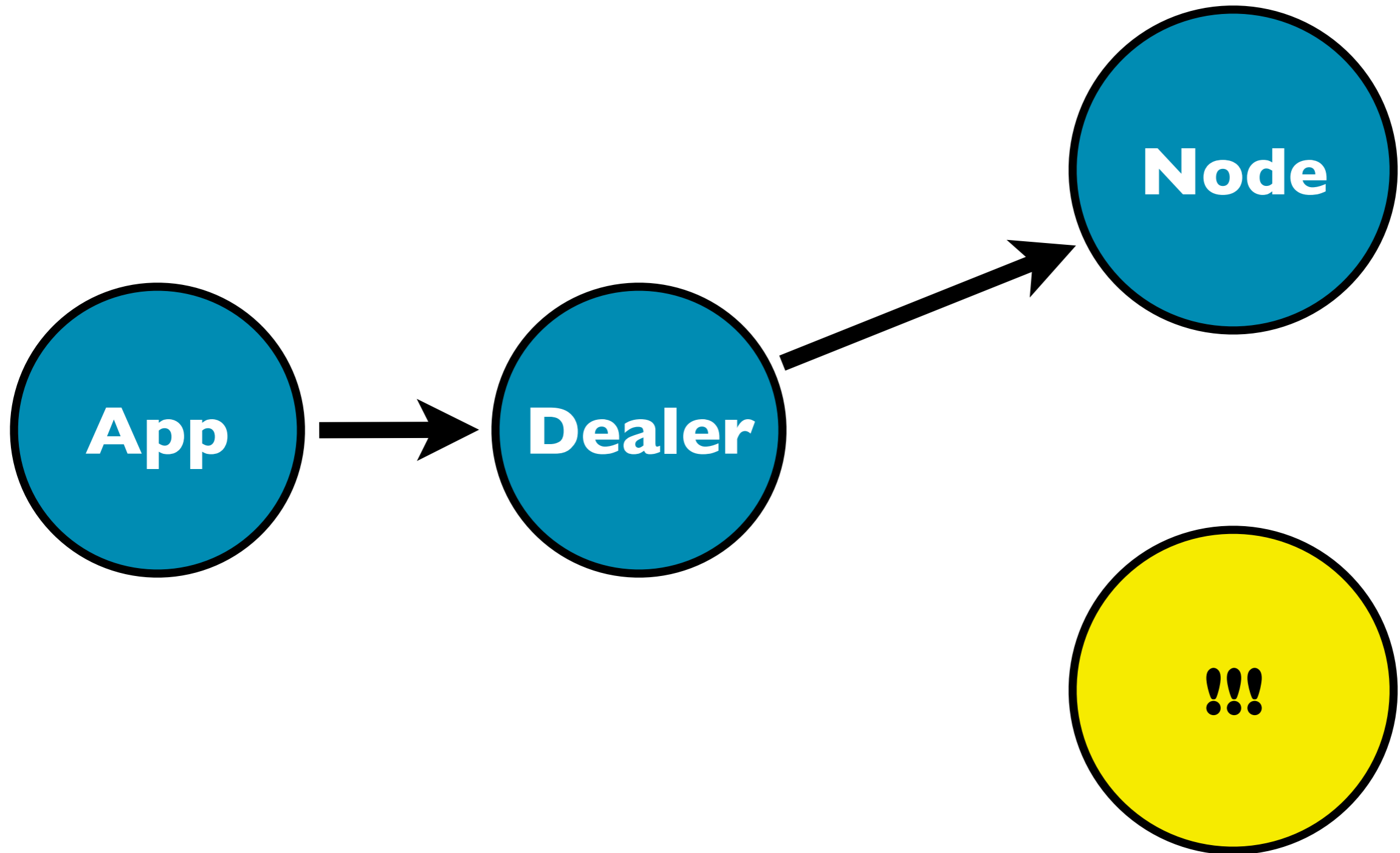

Health monitoring

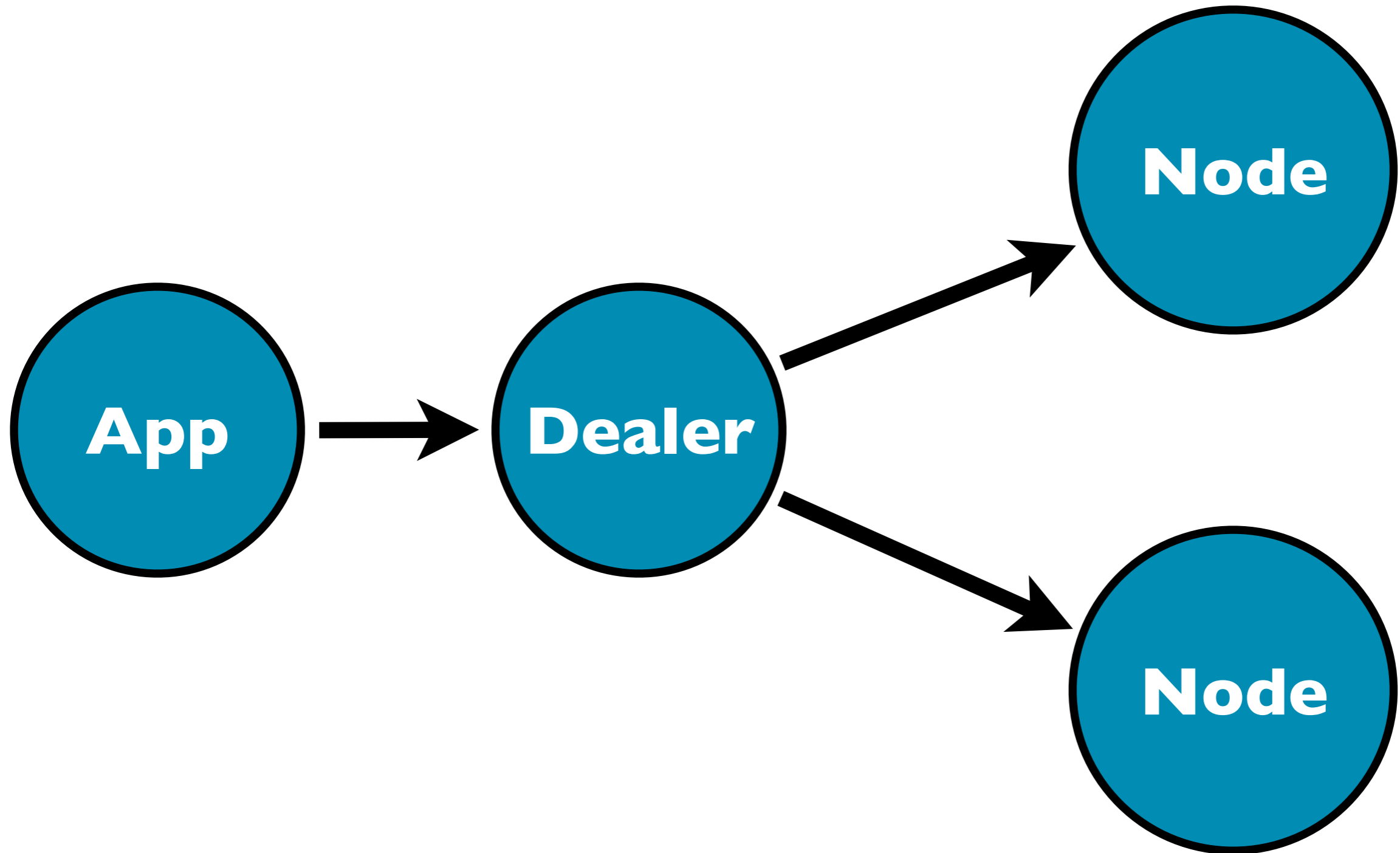

- 1. Performance**
- 2. Cloud awareness**
- 3. Always on**
- 4. Fine tuning**
- 5. Smart balancing**
- 6. Persistent delivery**
- 7. Health monitoring**

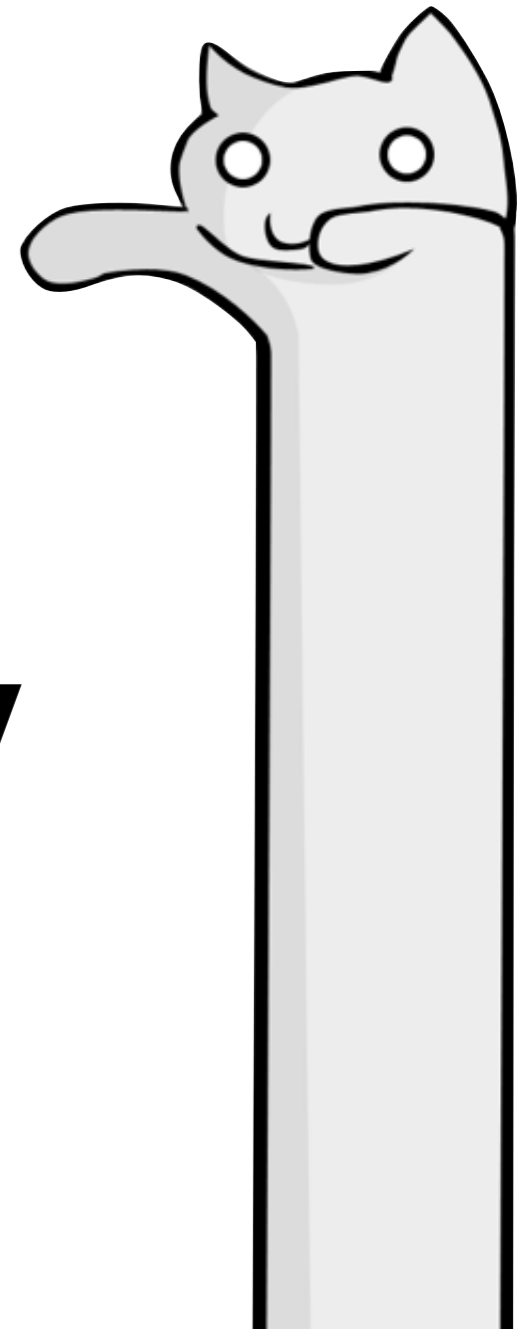

Simple API

```
dealer_t dealer("config.json");
```

```
message_path_t path("image_app", "filter");
```

```
dealer.send_message(image, path);
```

Cocaine Dealer — точка входа в облако.

- 1. Балансировщик**
- 2. Маршрутизатор**
- 3. Очередь запросов**

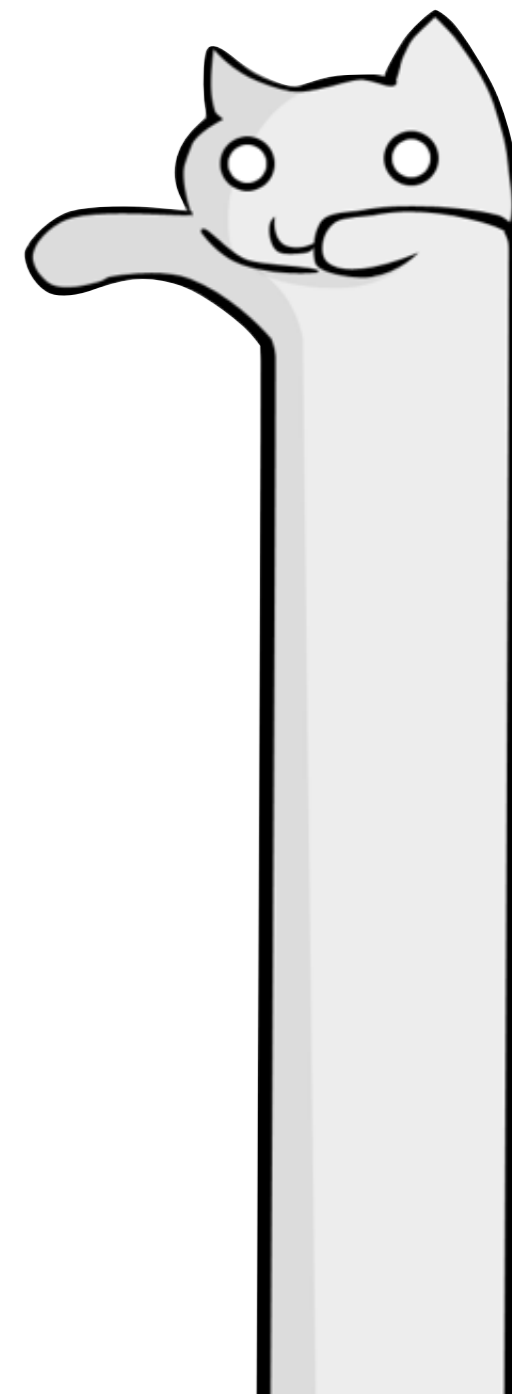



Рим Зайдуллин
Code Wizard

tinybit@yandex.ru

twitter.com/porca_troia

Спасибо